

Cellular IoT M2M RTU



S271

User Manual

Version: V1.0

Date: 2021-11-25

Shenzhen Beilai Technology Co., Ltd

Website: <https://www.bliiot.com>

Preface

Thanks for choosing BLIIoT Cellular IoT M2M RTU. These operating instructions contain all the information you need for operation of a device in the RTU S27 family.

Copyright

This user manual is owned by Shenzhen Beilai Technology Co., Ltd. No one is authorized to copy, distribute or forward any part of this document without written approval of Shenzhen Beilai Technology. Any violation will be subject to legal liability.

Disclaimer

This document is designed for assisting user to better understand the device. As the described device is under continuous improvement, this manual may be updated or revised from time to time without prior notice. Please follow the instructions in the manual. Any damages caused by wrong operation will be beyond warranty.

Revision History

Revision Date	Version	Description	Owner
November 25th, 2021	V1.0	Initial Release	XJH

Content

1 Introduction	5
1.1 Overview	5
1.2 Typically Applications	5
1.3 Safety Directions	6
1.4 Packing List	7
1.5 Features	7
1.6 Technical Specifications	9
1.7 Model Selection	11
2 Hardware Specifications	11
2.1 Size	11
2.2 Interface	12
2.2.1 Digital Input	12
2.2.2 LED Indicators	13
2.2.3 Digital Output	13
2.2.4 Analog Input	14
2.2.5 Temperature&Humidity	15
2.2.6 Power&Switch&Mode Settings	15
2.2.7 SIM Card Slot	15
3 Installation	16
3.1 Wall mounted	16
3.2 DIN Rail mounting	16
4 Configuration	17
4.1 Preparation before configuration	17
4.1.1 Install USB Driver	17
4.1.2 Check COM Port	18
4.1.3 Login Configuration Software	18
4.2 Basic Settings	19
4.3 Alarm Numbers Settings	20
4.4 Digital Output Settings	21
4.5 Access Control Settings	23

4.6 Input Settings	24
4.6.1 DI Setting	24
4.6.2 DI Alarm Settings	26
4.6.3 AI Setting	26
4.6.4 AI Alarm Settings	28
4.7 Timer Setting	29
4.8 Logic Trigger Setting	31
4.9 Cellular Network Settings	33
4.10 Historical Record	37
4.11 System	38
4.13.1 Export Configuration File	38
4.13.2 Load Configuration File	38
4.14.3 Reset	38
5 SMS Functions	38
5.1 SMS Command List	39
6 Communication Protocols	43
6.1 Modbus RTU Slave Application	44
6.1.1 Read DO State	44
6.1.2 Control DO	45
6.1.3 Read DI State	47
6.1.4 Read AI, Tem&Hum, DI0, Power value	48
7 Connect to Cloud Platform	50
7.1 BLIIoT Modbus Cloud	50
7.2 BLIIoT MQTT Cloud	52
7.3 Huawei Cloud	56
7.4 Ali Cloud	59
7.5 Other IoT Server	64
8 Device Register Address	65
9 Upgrade	67
10 Warranty Term	67
11 Technical Support	67

1 Introduction

1.1 Overview

The Cellular IoT M2M RTU is an industrial class, high reliability, high stability, and programmable Remote Terminal Unit (RTU). It embedded 32-Bit High Performance Microprocessor MCU, inbuilt industrial Cellular module. The RTU features 4 digital inputs, 4 analog inputs, 4 relay outputs, 1 ambient sensor input for monitoring onsite temperature and humidity.

Users can set high and low limit according to different application scenarios, when alarm occurs, the RTU will notify users by SMS, dialing, and also uploading data to cloud platform, monitoring center.

The RTU supports BLIIoT IoT RTU protocol, Modbus RTU over TCP protocol, Modbus TCP protocol, MQTT protocol, which can communicate directly with the server, cloud platform or SCADA. It is a cost effective IoT solution for industrial automation, security monitoring system, automatically measurement and control system, BTS monitoring, remote data acquisition, telemetry systems, automatically control system.

1.2 Typically Applications

BTS Monitoring, Security Alarm System applications, Supervision and monitoring alarm systems, Automatic monitoring system, Vending Machines security protection, Pumping Stations, Tanks, Oil or Water levels, Buildings and Real Estate, Weather Stations, River Monitoring and Flood Control, Oil and gas pipelines, Corrosion protection, Temperatures, Water leakage applications, Wellheads, boat, vehicle, Energy saving, street lights control system, Valve controls, Transformer stations, Unmanned machine rooms, Control room application, Automation System, M2M, Access Control System, etc.

S271 Application Diagram

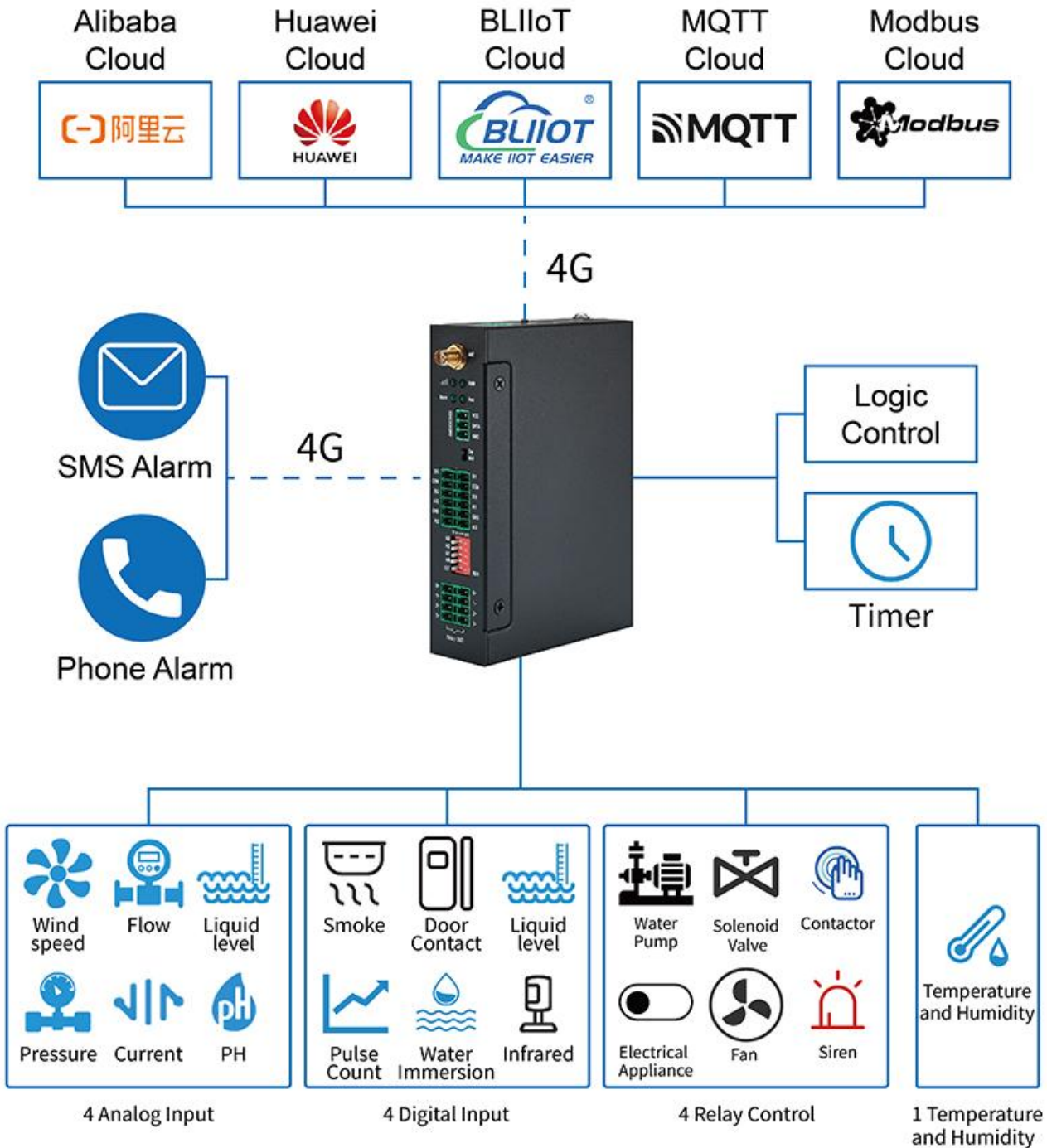

1.3 Safety Directions



Safe Startup

Do not use the unit when using 4G equipment is prohibited or might bring disturbance or danger.



Interference

All wireless equipment might interfere network signals of the unit and influence its performance.

1.4 Packing List

Please make sure below items are included in the package:

(Pictures are for reference only)

- 1xRTU, Wiring terminal, 1xMini USB, 1xSMA cellular antenna, 1xPower adaptor, DIN-Rail mounting clip kit, Ejection Pin, Product qualification certificate, Warranty card



1.5 Features

- 4G network communication, can be operated from anywhere, no distance limitation;
- Wide range power supply 12~36VDC with over voltage and phase-reversal protection;
- Embedded ARM Cortex-M4 32 Bit RISC Core RTOS system, reliable performance with in-built watchdog;
- 4 digital inputs, supports both dry contact and wet contact. Logic level: 10~30V or short circuit

treated as close, 0~3V or open circuits treated as open. DIN0 as a high-speed pulse counter, sampling frequency: 1MHz; DIN1~3 as low-speed pulse counter, DIN1 with arm and disarm function;

- 4 relay output (5A@30VDC, 5A@250VAC), can auto control by timer, alarm-link and remote control by SMS, cloud. The first DO can set time to control by authorize number;
- 1 temperature & humidity sensor input for monitoring onsite environment, temperatures range from -40°C to 80°C, with a 0.5°C accuracy, humidity range from 0 to 100RH%, with a 3% accuracy;
- 4 analog inputs, 12bits resolution, supports 0-5V, 0-20mA, 4-20mA output transducers;
- Inbuilt 2M EEPROM to save up to 200 historical data and events;
- Powerful SMS function
- Inbuilt 1 DC output for external transducers to save wiring cost;
- Automatically resend the data while communication interrupt or failure, and failure will alert by SMS;
- Supports remote restart by SMS commands;
- 10 SMS Alert and auto dial numbers for receiving alarm message, can program to receive specified alarm message. The authorized numbers also can dial to open the door or turn on/off machine at the specified time;
- Inbuilt inter-lock logic programmer and powerful timer program function;
- Support SMS, dial, 4G network for alert, USB port for configuration and upgrade firmware;
- Embedded TCP/IP protocol stack, support TCP/UDP, MQTT, Modbus TCP, Modbus RTU over TCP, BLIIoT IoT RTU protocol;
- Metal case with IP30 protection grade, safely isolated from inner system, especially suitable for industrial control application.
- Small size: 127mmx88mmx30mm, support wall-mounting and DIN Rail mounting.

1.6 Technical Specifications

Category	Parameter	Description
Power	Input Voltage	DC 12~36V
	Power Consumption	Normal: 50mA@12V, Max: 150mA@12V
	Output	1 Channel; Voltage: 12~36V DC; Current: 1500mA@12V(Max)
	Protection	Reverse wiring prevention; Surge: 4KV
	Backup Battery	3.7V/850mA (It is optional. Default: Without battery)
USB	USB	1xMini USB
Digital Input	QTY	4 Channel
	Type	Support both Wet contact and Dry contact
	Dry Contact	Close: Short circuit; Open: Open circuits
	Wet Contact	Close: 10~30V; Open: 0~3V
	Others	DIN0 as a high-speed pulse counter, sampling frequency: 1MHz; DIN1~3 as low-speed pulse counter, anti-shake time can be set 1~2000ms, default 1ms; DIN1 with arm and disarm function;
	Protection	2KVrms
Digital Output	QTY	4 Channel
	Type	Relay output (5A@30VDC, 5A@250VAC)
	Others	The first DO can set time to control by authorize number; Custom setting close and open times
	Protection	2KVrms
Analog Input	QTY	4 Channel
	Type	Single-ended input, 4-20mA/0-20mA/0-5V
	Resolution	12Bit
	Accuracy	±0.1% FSR @ 25°C ±0.3% FSR @ -10 and 60°C ±0.5% FSR @ -40 and 75°C
	Sampling Rate	200ms
	Input Impedance	>1M ohms
Temperature& Humidity (AM2301)	Resolution	16bit(0.1%RH, 0.1°C)
	Sampling Rate	200ms
	Temperature Range	-40 to +80°C
	Accuracy	0.5°C
	Humidity Range	0 to 99RH%
	Accuracy	3%RH
4G	SIM	Drawer type, Support 1.8V/3V SIM/UIM card, Built-in

		15KV ESD protection
	SIM Slot	1
	L-E Version	GSM/EDGE:900,1800MHz WCDMA:B1,B5,B8 FDD-LTE:B1,B3,B5,B7,B8,B20 TDD-LTE:B38,B40,B41
	L-CE Version	GSM/EDGE:900,1800MHz WCDMA:B1,B8 TD-SCDMA:B34,B39 FDD-LTE:B1,B3,B8 TDD-LTE:B38,B39,B40,B41
	L-A Version	WCDMA:B2,B4,B5 FDD-LTE:B2,B4,B12
	L-AU Version	GSM/EDGE:850,900,1800MHz WCDMA:B1,B2,B5,B8 FDD-LTE:B1,B3,B4,B5,B7,B8,B28 TDD-LTE:B40
	L-AF Version	WCDMA:B2,B4,B5 FDD-LTE:B2,B4,B5,B12,B13,B14,B66,B71
	CAT-1 Version	GSM:900,1800 FDD-LTE:B1,B3,B5,B8 TDD-LTE:B34,B38,B39,B40,B41
Software	Internet Protocol	IPV4, TCP/UDP, Modbus RTU, Modbus TCP, MQTT, BLIIoT IoT RTU
	Indicator	4G signal, running, arming and disarming
	Configuration	PC software configuration, support WIN XP, WIN 7, WIN 8 and WIN 10
	Transparent Transmission	Support
	SMS Command	Support
	Login Package	Support custom login package
	Heartbeat Package	Support custom heartbeat package
	Storage	Capable of storing up to 200 historical records
Environment	Working	-45~85°C, 5~95% RH
	Storage	-45~105°C, 5~95% RH
Others	Shell	Metal
	Size	127x88x30mm
	Protection	IP30
	Installation	DIN Rail mounting, Wall-mounted.

1.7 Model Selection

Model	DI	AI	DO	Tem& Hum	Storage	USB	RS485	I/O data points			
								bool	16Bit	32Bit	64Bit
S270	2	2	2	1	2M	1	x	x	x	x	x
S271	4	4	4	1	2M	1	x	x	x	x	x

2 Hardware Specifications

2.1 Size

Dimension



2.2 Interface

Hardware Interface

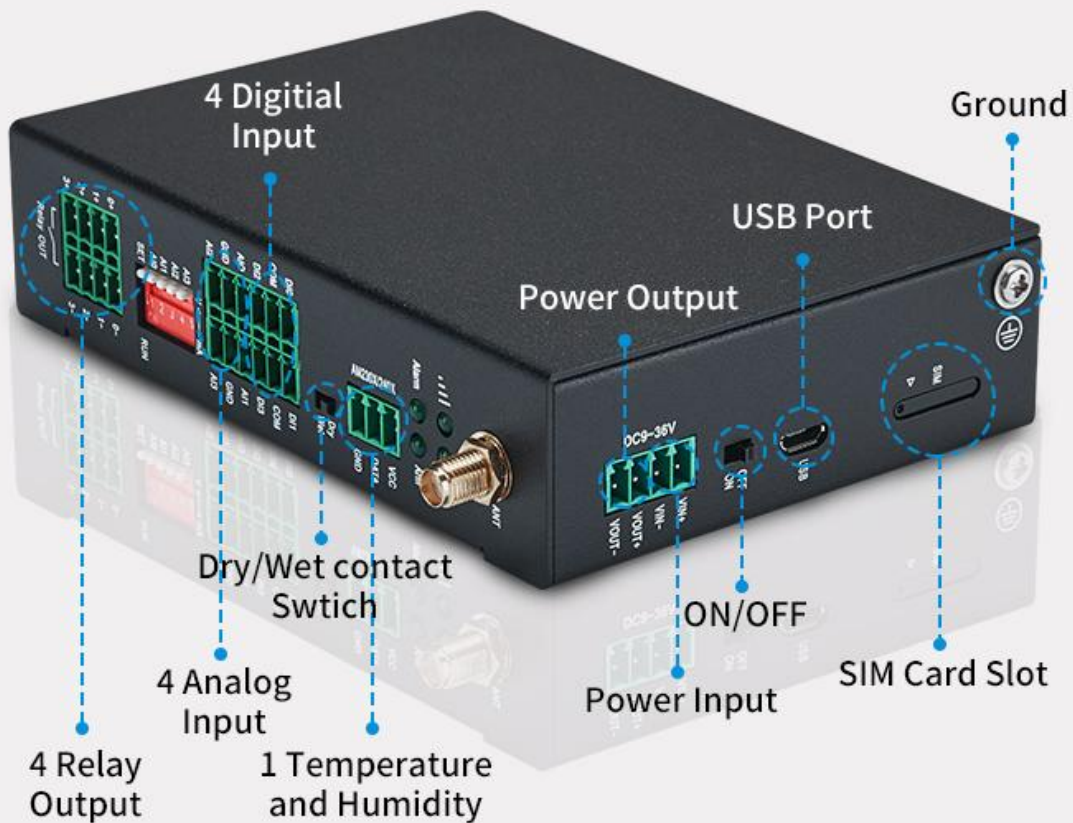

2.2.1 Digital Input

Digital Input	
Function	Description
DI0	First channel of Digital input, support high speed pulse counting, sampling frequency: 1MHz
DI1	Second channel of Digital input, support low speed pulse counting, support used as arming and disarming input

DI2	Third channel of Digital input
DI3	Fourth channel of Digital input
COM	Common grounding
COM	Common grounding
Dry	DI switch to Dry contact
Wet	DI switch to Wet contact

Note: DIN0 as a high-speed pulse counter, sampling frequency: 1MHz; DIN1~3 as low-speed pulse counter, anti-shake time can be set 1~2000ms, default 1ms;

Diagram of DI internal interface:

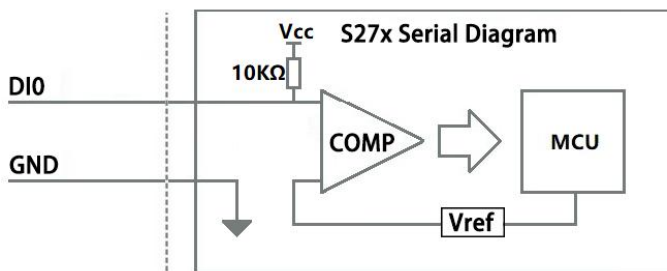

2.2.2 LED Indicators

LED Indicators				
Symbol	Name	Color	State	Description
	4G signal	GREEN	Flickering	Normal(Light Off for 0.2s, ON for 2s)
			OFF	No signal(Light Off for 2s, ON for 0.2s)
Alarm	Alarm	RED	Always ON	Triggered alarm
			OFF	No alarm
Run	Run	RED	Flickering	System is running
			OFF	System stop running
Arm	Arm	RED	Always ON	Armed
			OFF	Disarmed

2.2.3 Digital Output

Digital Output	
Functions	Description
DO0+	First channel of Digital output
DO0-	First channel of Digital output
DO1+	Second channel of Digital output

DO1-	Second channel of Digital output
DO2+	Third channel of Digital output
DO2-	Third channel of Digital output
DO3+	Fourth channel of Digital output
DO3-	Fourth channel of Digital output

Diagram of DO internal interface:

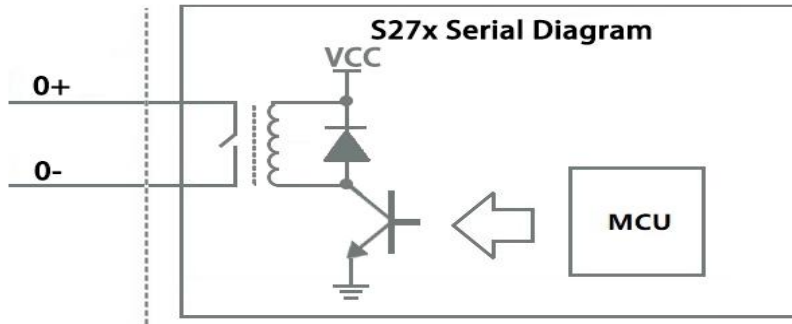

2.2.4 Analog Input

Mode selection(DIP Switch)	
Functions	Description
V	Switch to "V" indicate that the analog input type is "0-5V"
mA	Switch to "mA" indicate that the analog input type is "0-20mA" or "4-20mA"
A0-A3	Corresponding to the analog input of each channel

Note: According to the output type of the transmitter(mA or V), switch the DIP switch of the corresponding channel to the corresponding position on the device.

Analog Input	
Functions	Description
AI0	First channel of Analog input positive interface
AI1	Second channel of Analog input positive interface
AI2	Third channel of Analog input positive interface
AI3	Fourth channel of Analog input positive interface
GND	Common grounding
GND	Common grounding

Diagram of AI internal interface:

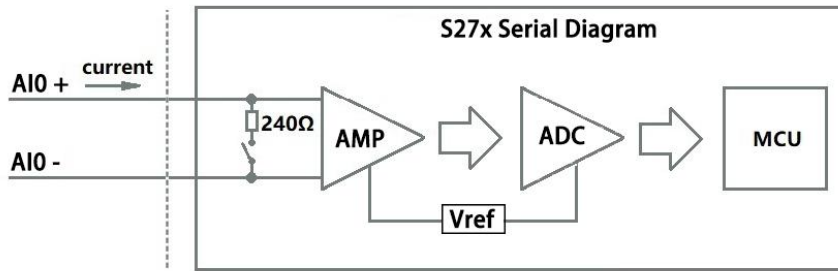

2.2.5 Temperature&Humidity

RS485 and Temperature&Humidity	
Functions	Description
VCC	Power supply interface of Tem &Hum sensor(AM230x/AM240x)
DATA	Data interface of Tem &Hum sensor(AM230x/AM240x)
GND	Grounding of Tem &Hum sensor(AM230x/AM240x)

2.2.6 Power&Switch&Mode Settings

Power&Switch	
Functions	Description
VIN+	12-36V Power input positive
VIN-	12-36V Power input negative
VOU+	12-36V Output positive
VOU-	12-36V Output negative
OFF	Device shutdown
ON	Device startup
USB	Used to connect configuration software, set parameters, and upgrade
Configuration Switch	
Functions	Description
SET	Switch to SET to enter configuration mode when configuring
RUN	When configuring is complete, switch to RUN to enter the running mode.

2.2.7 SIM Card Slot

When inserting/removing the SIM card, please turn off the device.

Note: Please place the device flat when inserting/removing the SIM card.

3 Installation

3.1 Wall mounted

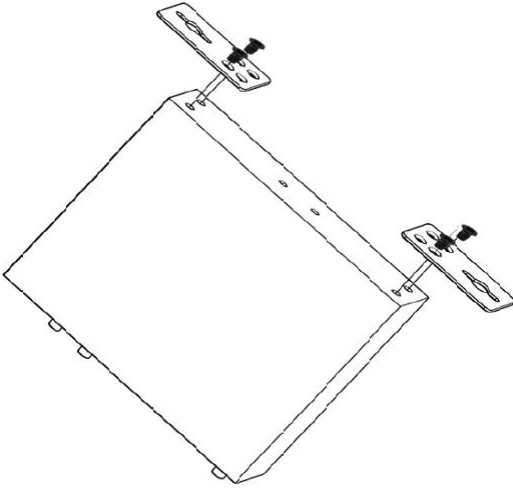

3.2 DIN Rail mounting



4 Configuration

4.1 Preparation before configuration

Please follow the steps

- 1) Insert the SIM Card;
- 2) The device must be configured in [SET] mode, switch to [SET] before configuration;



- 3) Connect the device to an external power and power on, switch the power switch to ON.
- 4) Connect the RTU to PC by USB cable, and install the USB Driver to the computer;
- 5) Open configuration software, choose the correct COM port and fill in the password(Default: 1234), select Normal SIM card mode to enter configuration software;
- 6) Open parameter setting page---->Click "Read" button to get device current value--->After modifying or setting the parameters---->Click the "Save" button to saving parameters in device;
- 7) If you need to program bulks of RTU with similar parameters, you can [Export Configuration File], and then [Load Configuration File] to the next device to complete the settings quickly;
- 8) Power off the device when configuration is complete, switch the power switch to OFF;
- 9) Switch to [RUN] mode after power off the device;
- 10) Reboot the device, then the device will enter into normal running mode.

4.1.1 Install USB Driver

Install the USB Driver to the computer firstly. When successful, it can be found out at the device manager of the XP or Windows 7 or Win8/Win10. Also, the driver for different OS can be downloaded from Silicon Laboratories, Inc. <http://www.silabs.com> , the model is CP210x.

4.1.2 Check COM Port

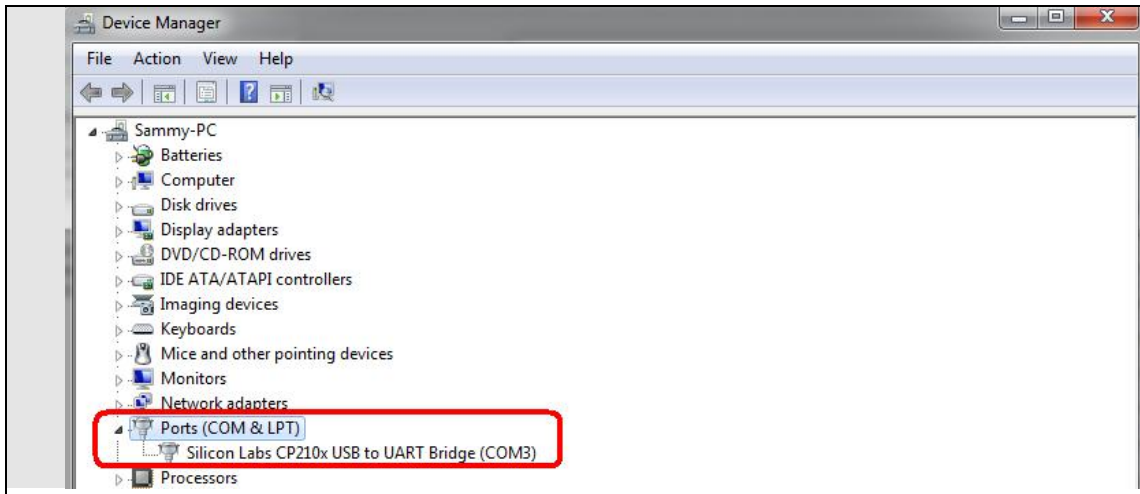

Choose the correct "COM port" when entering configuration software.

4.1.3 Login Configuration Software

Choose the correct port, then fill in the password to login configuration software

The login password is 1234

Click "Read" button to get device current parameters first

Click "Save" button to saving parameters in device

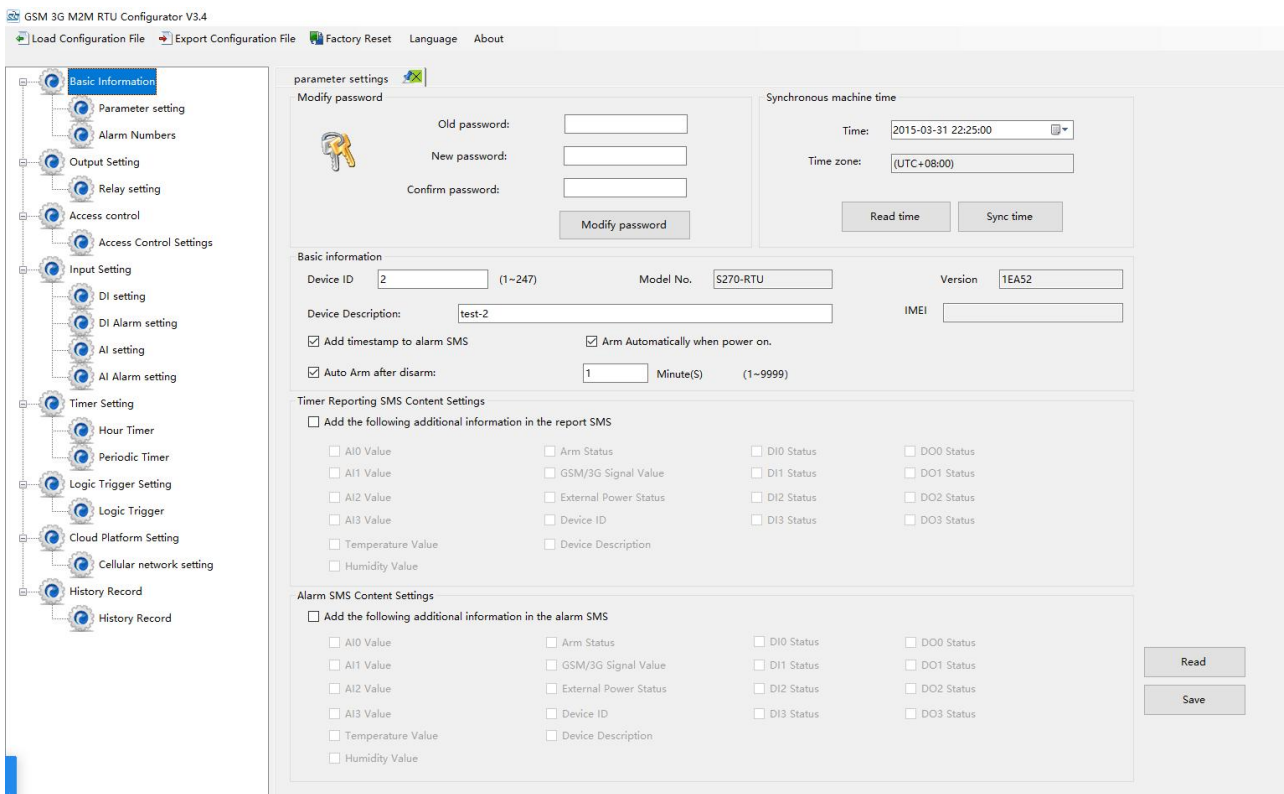

4.2 Basic Settings

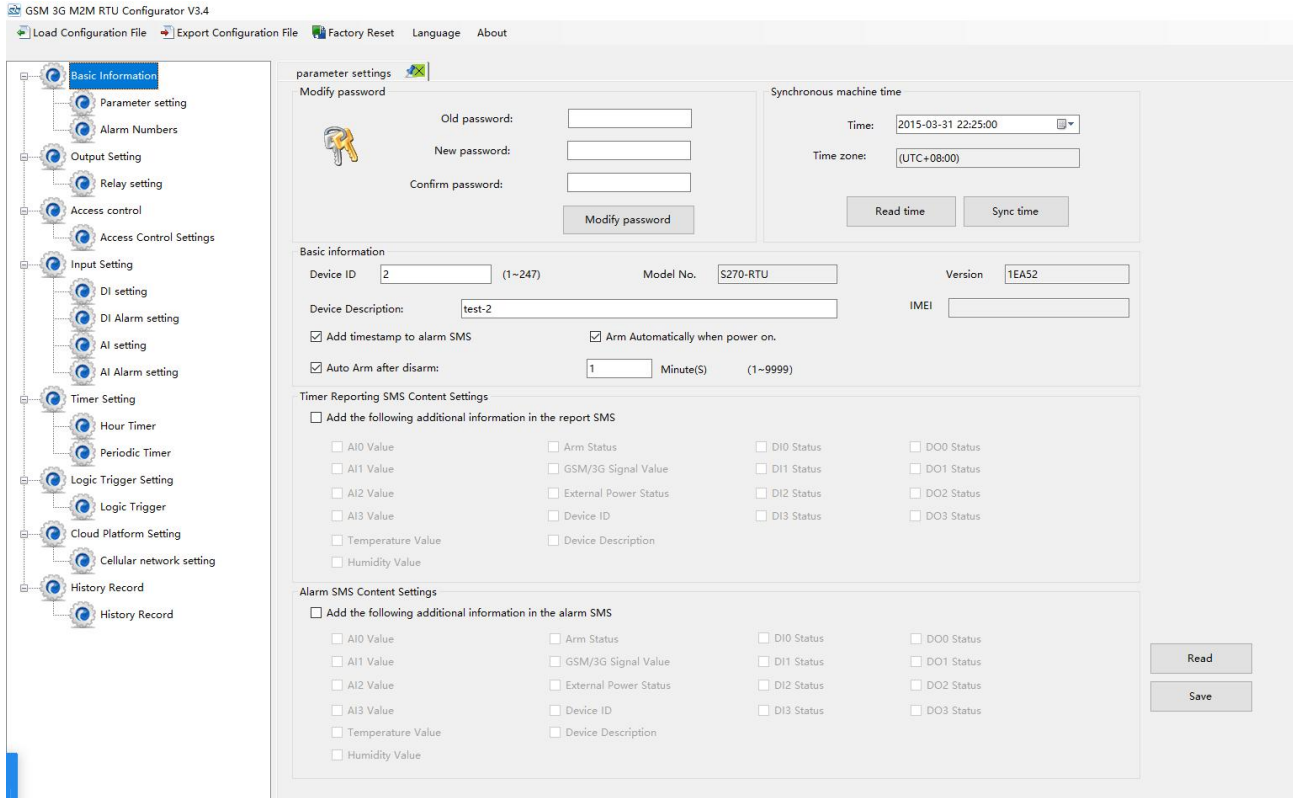

Modify Password		
Item	Description	Default
Old password	Enter the old password	Empty
New password	Enter the new password	Empty
Confirm password	Confirm the password	Empty
Modify password	Password modification takes effect	--
Synchronous machine time		
Item	Description	Default
Time	Current time on device	--
Time zone	Current time zone on computer	--
Sync time	Time on computer is synchronized with RTU	--
Read time	Read the current time	--

Basic information		
Item	Description	Default
Device ID	Modbus device ID address, range: 1-247	1
Model No.	Device model number	--
Version	Device version	--
IMEI	Device serial number	--
Device description	The alarm message will include device description	Empty

	information.	
Add timestamp to alarm SMS	Alarm message will include the time	Check
Arm automatically when power on	RTU will enter into Arm mode automatically once the RTU powered on	Check
Auto arm after disarm	RTU will change to arm mode automatically after a certain period after disarm	Check

Timer reporting SMS content settings		
Item	Description	Default
Add the following additional information in the report SMS	Check the related item to add its value/status to the Timer report text message.	Uncheck

Alarm SMS content settings		
Item	Description	Default
Add the following additional information in the alarm SMS	Check the related item to add its value/status to the alarm text message.	Uncheck

4.3 Alarm Numbers Settings

When device connect to cloud platform, it may be frequently offline due to sending text message, receiving text message and dialing. We don't suggest you use SMS alarm if RTU need to be connected to cloud platform.

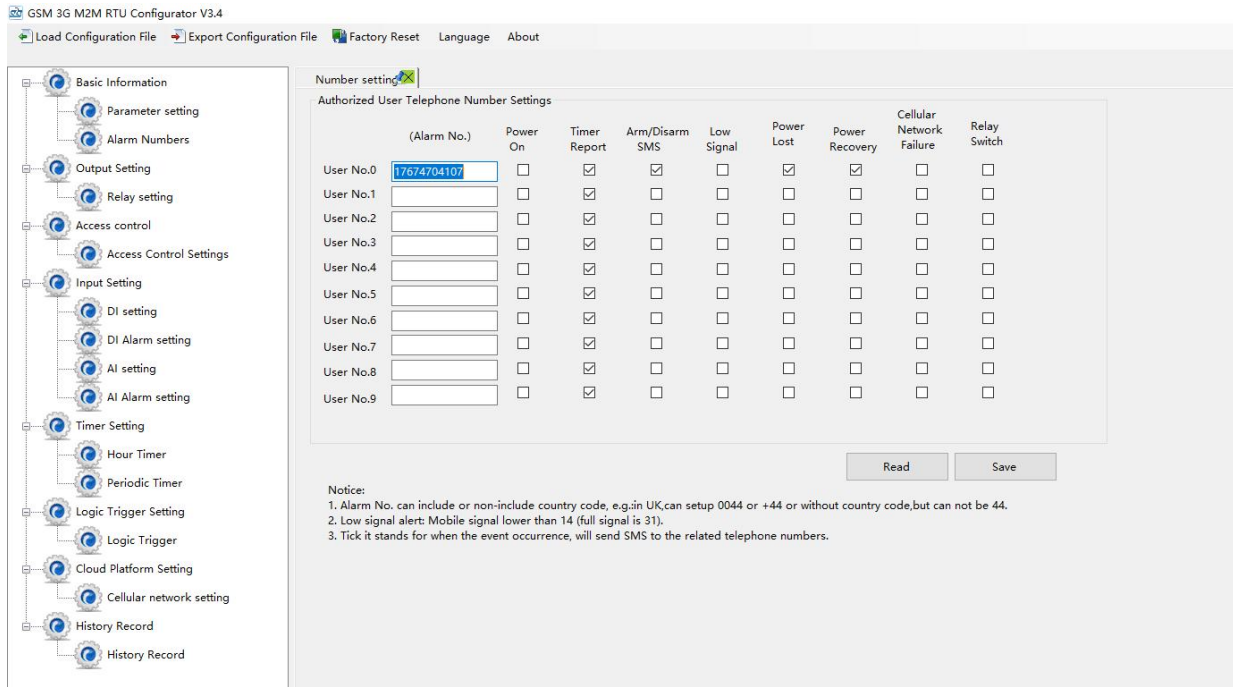

Authorized user telephone number settings		
Item	Description	Default
Alarm No.	Authorized mobile numbers to receive the alarm text message or dial	--
Power on	Text message will be sent when RTU powered on, the message includes device model, version, description, IMEI, status, signal value etc....	--
Timer report	Timer report text message will be sent	--
Arm/Disarm SMS	Text message will be sent when the state(Arm or Disarm) of RTU changed.	--
Low signal	Text message will be sent when 4G signal strength lower than 14	--
Power lost	Text message will be sent when external DC power loss	--
Power recovery	Text message will be sent when external DC power restored	--
Cellular network failure	Text message will be sent when re-connection failed three times.	--
Relay switch	Text message will be sent when relay state changes	--

4.4 Digital Output Settings

No need to set Channel name, ON/OFF SMS, Open description, Close description when device

connect to cloud platform.

This device features 4 relay outputs, rated range: 5A/30VDC, 5A/250VAC. It can be set as an authorized number to call in for control, or it can be controlled remotely by SMS, or timer, event correlation automatic control, or remote control via the monitoring center and cloud platform.

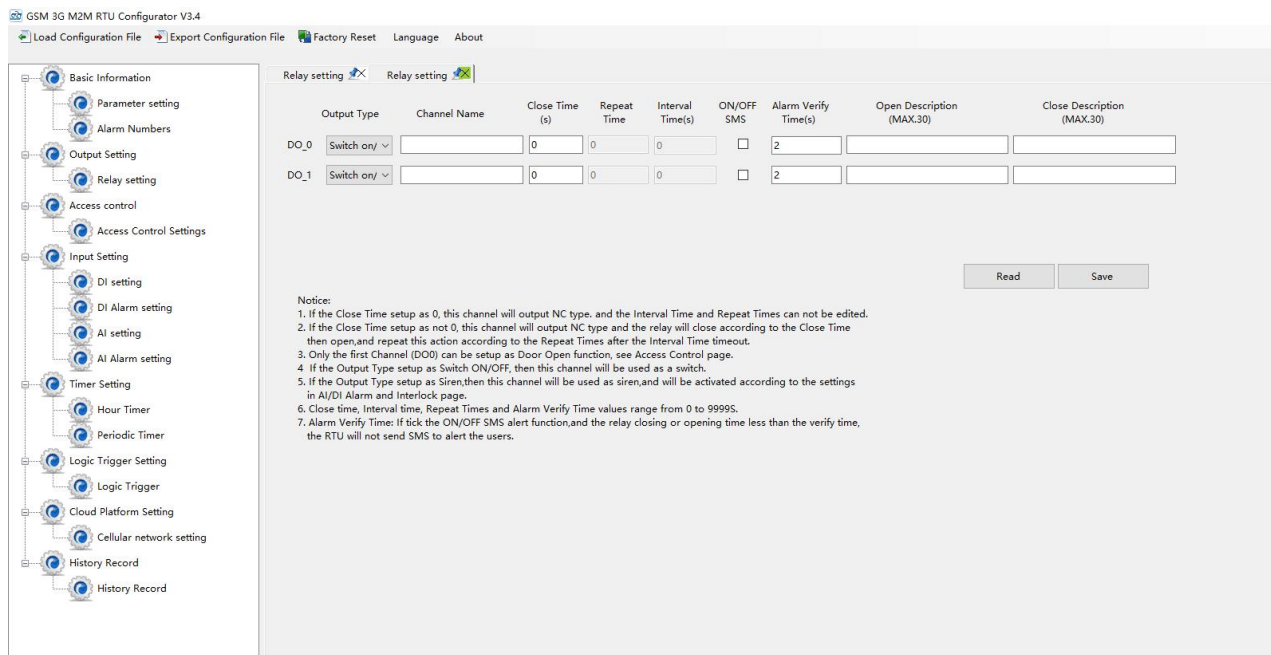

Relay Output settings		
Item	Description	Default
Output type	<p>Support 3 output types</p> <ul style="list-style-type: none"> ● Open door: Only the first Channel(DO0) can be set as Open Door, DO0 will close and the device will be automatically set to disarm status when the authorization number calls in. When DO0 used as Open door, then it cannot be used as regular ON/OFF switch ● Siren: Only DO1 can be set as Siren, DO1 will close when the siren function(DI setting) is executed ● Switch ON/OFF: The relay is used as a switch, it can be used as a normal timing event, linkage event, and SMS control. 	Switch on/off
Channel name	Custom setting channel name, in order to identify it in text message.	Empty
Close time	Relay close and last time, 0 second means always close.	0
Repeat times	Times to repeat closure when the relay action is performed.	0

Interval times	The interval time of relay repeating the close and open action. Use it with "repeat times", you can consider it as pulse output. The unit is second.	0
ON/OFF SMS	Text message will be sent when relay state changes	Uncheck
Alarm verify times	Alarm after a period when the relay state changed	0
Open description	Description of "OPEN" state in the text message	Empty
Close description	Description of "CLOSE" state in the text message.	Empty

4.5 Access Control Settings

No need to set this when device connect to cloud platform

This function is valid only when the DO0 is set as open door.

Users can quickly set the number and time period for call-in control. It is really convenient for remote control of electric locks in unattended computer rooms. It is possible to remotely authorize a certain maintenance personnel to open the door by calling in with his mobile phone within a limited period of time, which solves the traditional cumbersome approval process that takes a lot of time to pick up and deliver keys. And you can also set various parameters on this page through SMS, cloud platform, and monitoring center..

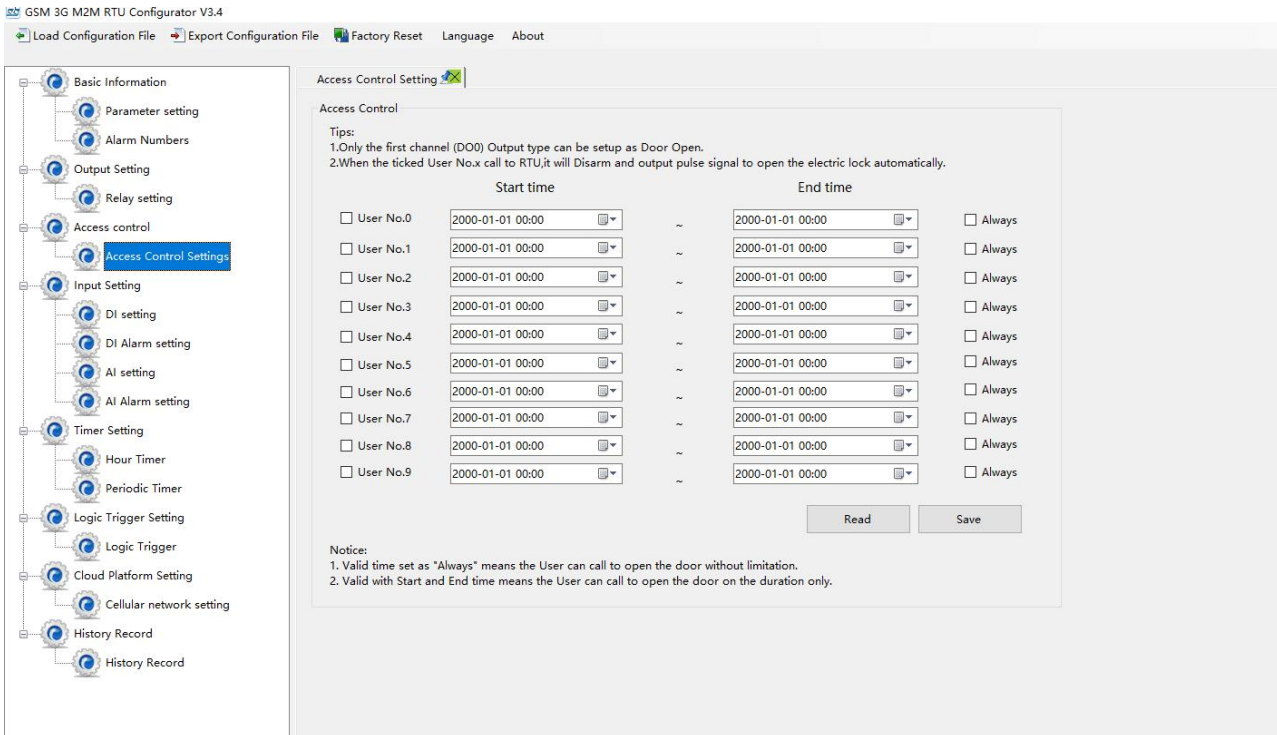

Access Control		
Item	Description	Default

User No.0-No.9	Authorized mobile number	Uncheck
Start time	Mobile number call-in permission start time	--
End time	Mobile number call-in permission end time	--
Always	You can call in to open the door at any time	Uncheck

4.6 Input Settings

4.6.1 DI Setting

When device connect to cloud platform, it may be frequently offline due to sending text message, receiving text message and dialing.

No need to set [Alarm SMS], [Recover SMS], [Change SMS], [Interval alarm SMS] and [Total alarm value] when device connect to cloud platform.

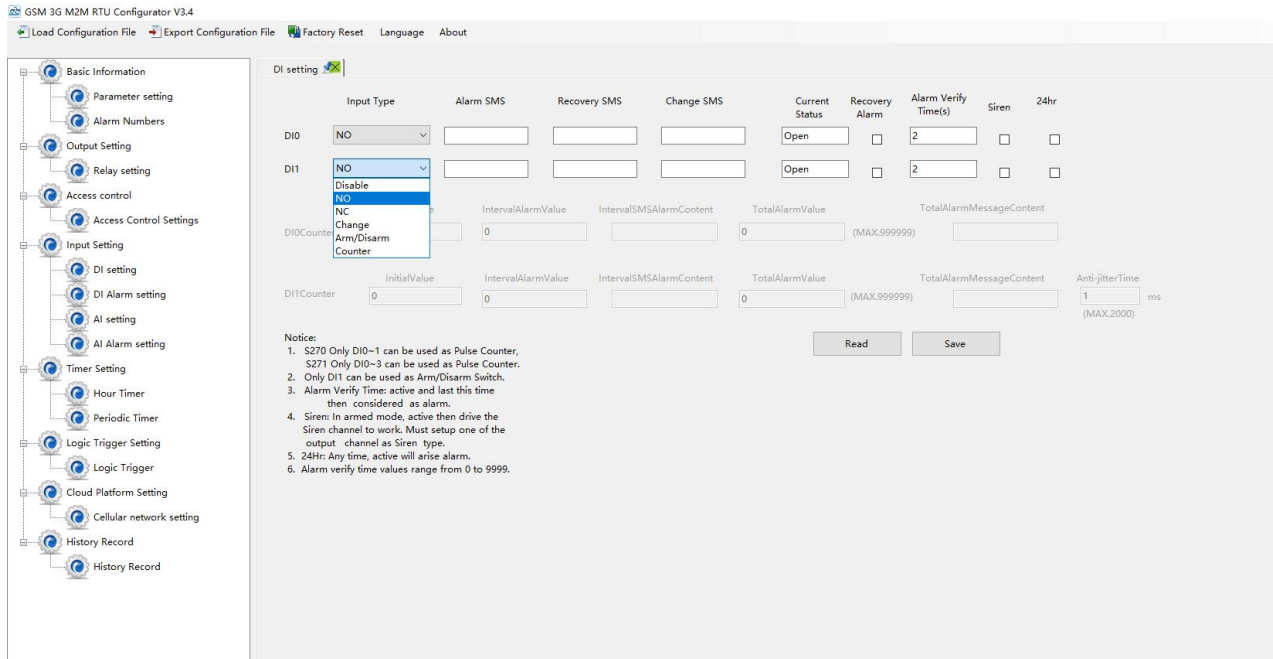

Select the corresponding input type according to the detector.

DI setting		
Item	Description	Default
Input type	<ul style="list-style-type: none"> ● Disable: Digital input of this channel unable to use ● NO: The normal state of the digital input is normally open, and the normally closed state is an abnormal event. ● NC: The normal state of the digital input is normally closed, and the normally open state is an abnormal event. 	

	<ul style="list-style-type: none"> ● Change: Each time the state of the digital input changes, it will be treated as an abnormal event ● Counter: DIN0 as a high-speed pulse counter, sampling frequency: 1MHz; DIN1~3 as low-speed pulse counter, anti-shake time can be set 1~2000ms, default 1ms; ● Arm/Disarm: Only DIN1 can be set as Arm/Disarm. The arm and disarm state will switch when DI changes from NO to NC 	
Alarm SMS	The text message sent to authorized numbers when alarm occurs	Empty
Recover SMS	The text message sent to authorized numbers when alarm restored	Empty
Change SMS	When DI input type set as "Change", the text message you entered here will be sent once the alarm occurs	Empty
Current status	Current state of digital input	--
Recovery alarm	Under the arm or 24-hour state, when alarm restored, the text message will be sent to authorized numbers	Uncheck
Alarm verify time	When the abnormal event last more than this period, it will be treated as a true alarm. The unit is second	1
Siren	Enable the Siren function, when DO1 set as Siren, DO1 will close when the alarm occurs	Uncheck
24hr	Alarm will be triggered no matter RTU is in Arm or Disarm mode	Uncheck

Counter		
Item	Description	Default
Counter	Pulse counter	Uncheck
Initial value	Initial value to start counting	Empty
Interval alarm value	Alarm occurs when counting to the interval value	Empty
Interval alarm SMS	The text message sent to authorized numbers when interval alarm happens	Empty
Total alarm value	When counts to the total value, it will automatically clear the count value to the initial value	Empty
Total alarm SMS	The text message sent to authorized numbers when counts to the total value	Empty

Anti-jitter time	Unit: ms, default 1, indicates that the maximum pulse sampling frequency is 1KHz; when the pulse frequency is low, appropriately increasing the anti-shake time can improve the accuracy. (Pulse sampling frequency = 1000/anti-jitter time, for example, 1ms corresponds to 1000Hz, 10ms corresponds to 100Hz, 100ms corresponds to 10Hz, 1000ms corresponds to 1Hz)	1
When using counter function, please switch the DIP switch on device to Wet.		

4.6.2 DI Alarm Settings

When device connect to cloud platform, it may be frequently offline due to sending text message, receiving text message and dialing.

Users can authorize a certain person to receive alarm

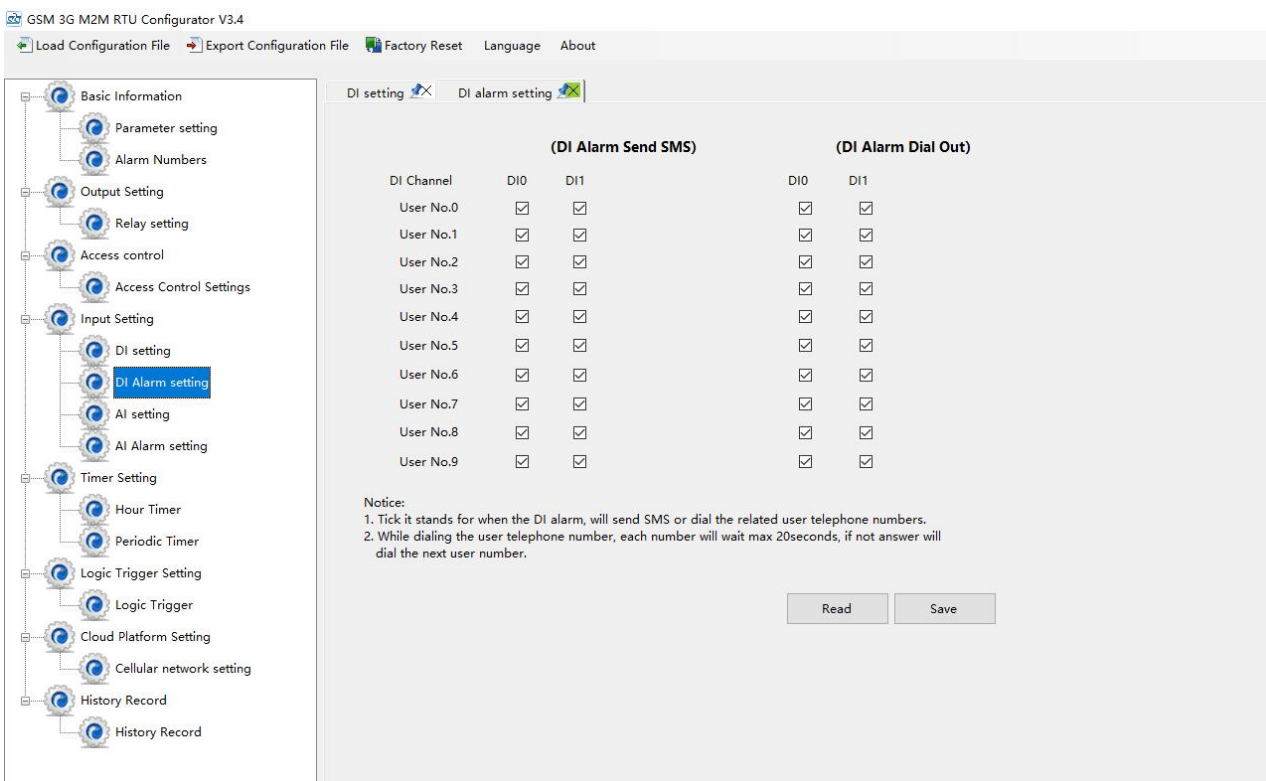

4.6.3 AI Setting

Analog input can be used for temperature monitoring, current monitoring, voltage monitoring, power factor monitoring, water level monitoring, pressure monitoring, environmental monitoring, wind speed monitoring, etc. Users can set high and low limit alarm thresholds and restore alarms according to needs. When the limit is exceeded or recovered, personalized notifications can be set to specific

users.

This device features 4 analog input, 12-bit resolution, 200ms sampling frequency, and supports 0-5V, 0-20mA, 4-20mA output sensors. It can be flexibly combined for measurement and monitoring of various different applications. Such as three-phase current and voltage monitoring and so on.

Note: Analog input type

There is DIP switch on the device, switch to mA or V type according to the output type of the transmitter.

- 2) The input type you choose in the configuration software should be the same as the DIP switch
- 3) For information on measuring ranges, please refer to transmitter specification

The device features 1 temperature & humidity sensor input for monitoring onsite environment,, temperatures range from -40°C to 80°C, with a 0.5°C accuracy, humidity range from 0 to 100RH%, with a 3% accuracy;

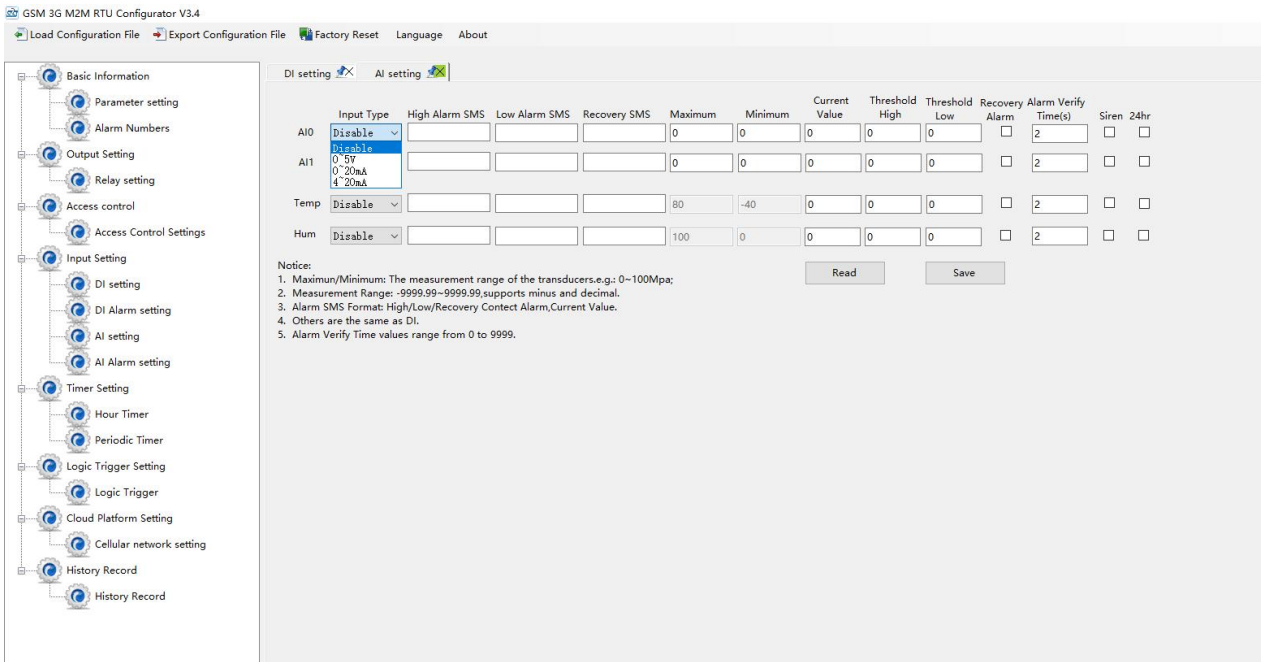
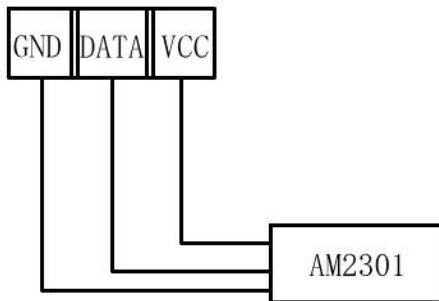

No need to set [High alarm], [Low alarm], [Recovery], when device connect to cloud platform.

AI setting		
Item	Description	Default
Input Type	Disable: Do not use this channel	Disable

	Enable: Use this channel 0~5V: Connect sensors with 0-5V output 0~20mA: Connect sensors with 0~20mA output 4~20mA: Connect sensors with 4~20mA output	
High alarm SMS	The text message sent to authorized numbers when current value higher than upper limit	Empty
Low alarm SMS	The text message sent to authorized numbers when current value lower than lower limit	Empty
Recovery SMS	The text message sent to authorized numbers when current value return to normal	Empty
Maximum	The maximum measuring range of the sensor	Empty
Minimum	The minimum measuring range of the sensor	Empty
Current Value	Refer to the current real value, such as the pressure is xxxPa, or the temperature is xxx°C and other specific values.	--
Threshold High	When the current value exceeds the upper limit of the alarm, an alarm will be triggered;	Empty
Threshold Low	When the current value is lower than the alarm lower limit value, an alarm will be triggered;	Empty
Recovery Alarm	When the value returns to the normal range, a text message will be sent to authorized numbers	Uncheck
Alarm verify time	When the abnormal event last more than this period, it will be treated as a true alarm.	1
Siren	When DO1 set as Siren, DO1 will be closed when the alarm occurs	Uncheck
24hr	Alarm will be triggered no matter RTU is in Arm or Disarm mode	Uncheck

4.6.4 AI Alarm Settings

Users can authorize a certain person to receive alarm

When device connect to cloud platform, it may be frequently offline due to sending text message, receiving text message and dialing.

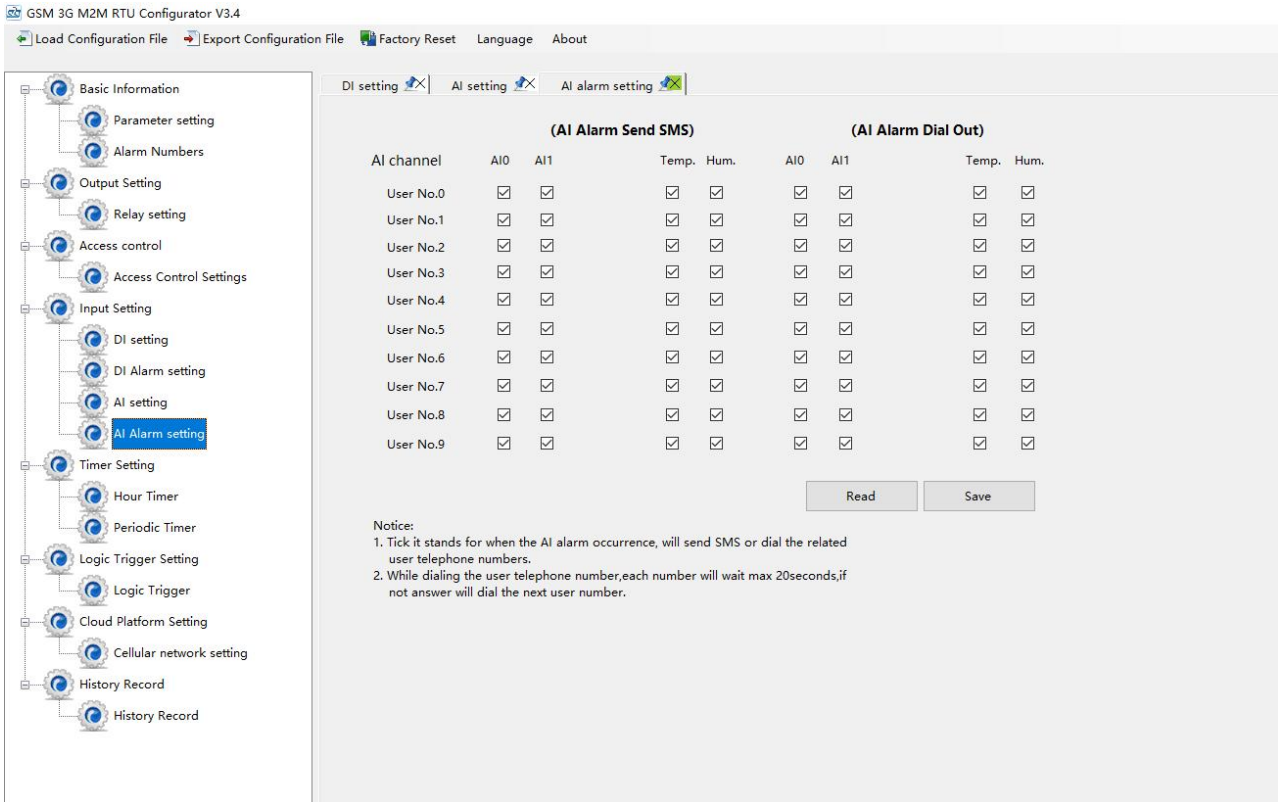

4.7 Timer Setting

The device is able to perform certain actions automatically at a preset time, which can effectively reduce human participation and greatly improve efficiency. For example, turn on the water pump regularly, discharge sewage regularly, start the exhaust fan regularly, switch equipment on and off at regular intervals, and so on.

In addition, this device supports a variety of timing functions, which can meet the application requirements of most places. For example, it can perform certain actions according to a certain time every day and every week, and start from a certain preset time point. Interval a certain preset time, and then execute a certain action periodically, a total of 10 timing events can be set.

1) Hour Timer

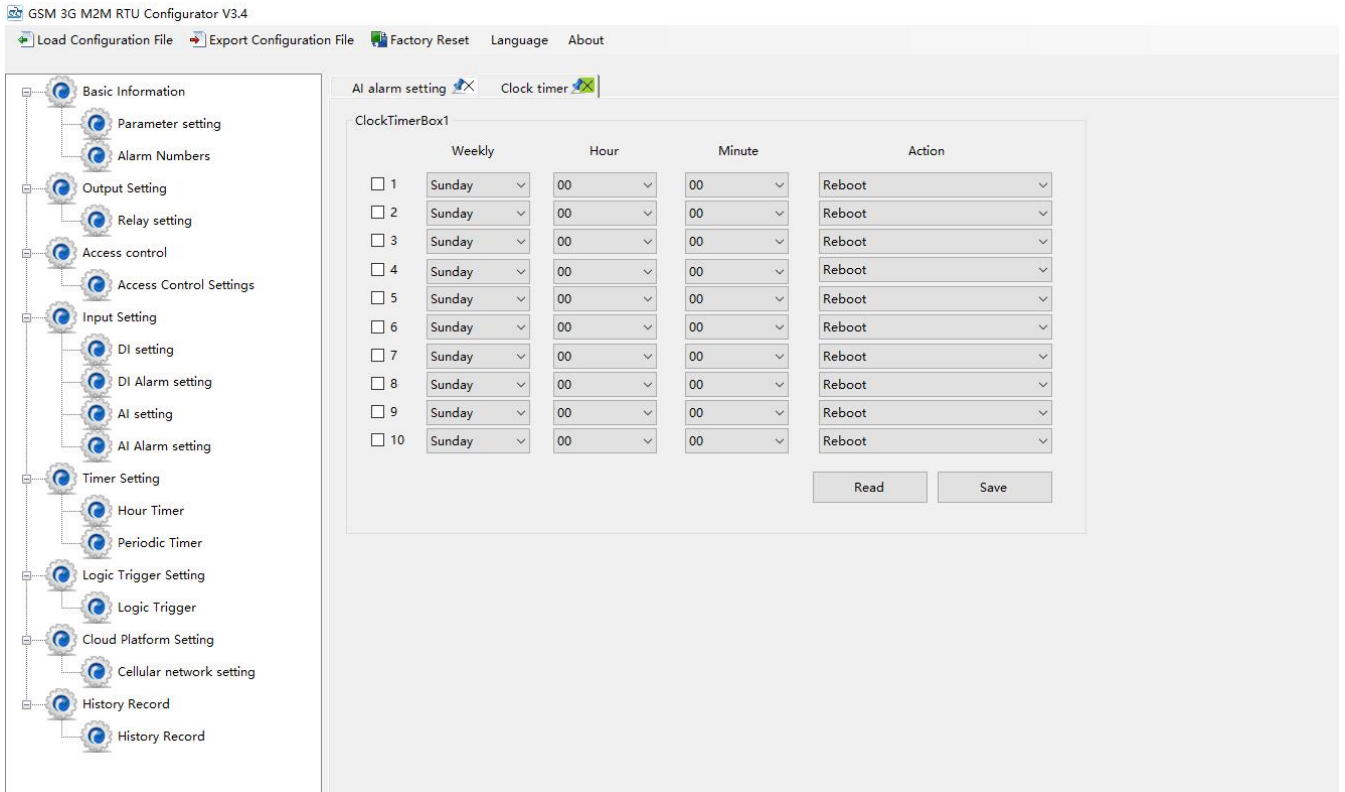

Hour Timer		
Item	Description	Default
1-10	Represents timers 1-10	Uncheck
Weekly	Monday to Sunday or Everyday	--
Hour	Specific hour	--
Minute	Specific minute	--
Action	The action to be executed at preset time	--

2) Periodic Timer

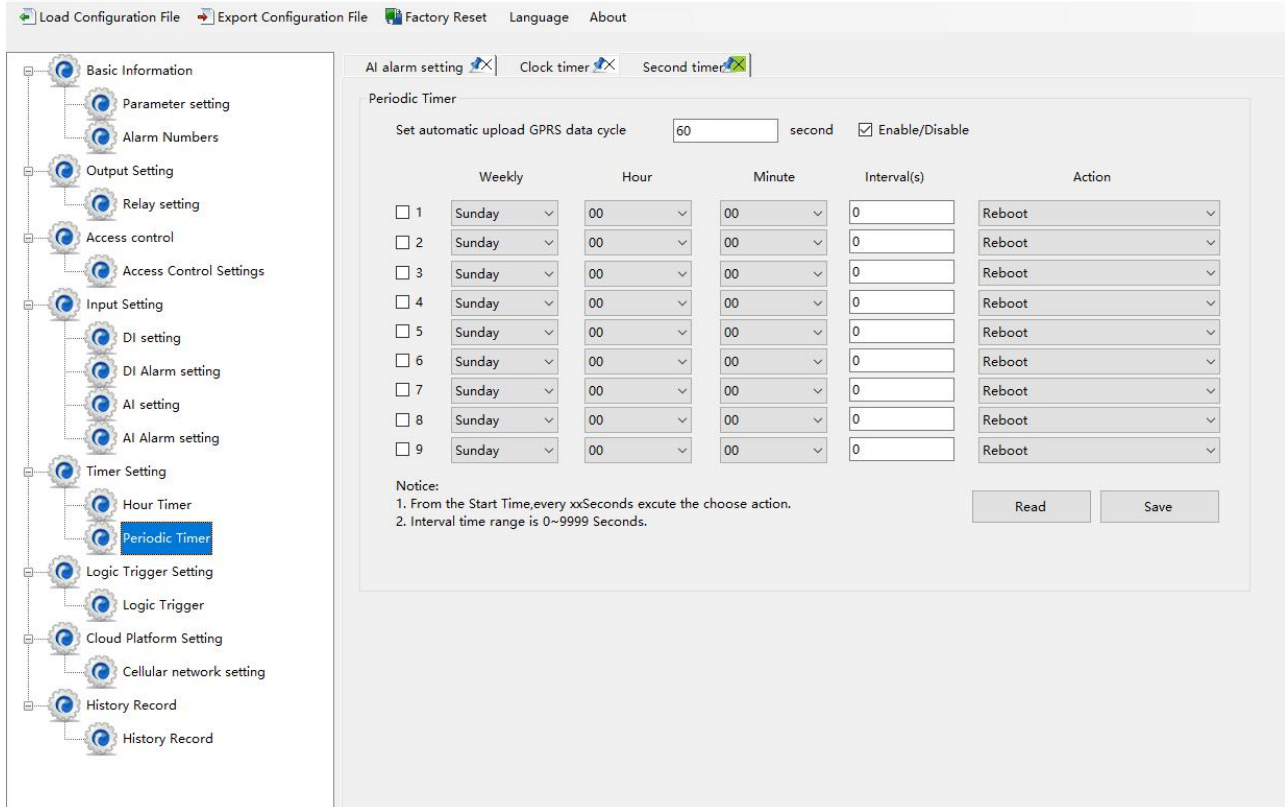

Periodic Timer		
Item	Description	Default
Set automatic upload GPRS data cycle	When 4G data transmission protocol is BLIIoT IoT RTU Protocol, enable periodically auto upload is the default. Unit: second	60
1-9	Represents timers 1-9	Uncheck
Weekly	Monday to Sunday or Everyday	--
Hour	Specific hour	--
Minute	Specific minute	--
Action	The action to be executed at preset time	--

4.8 Logic Trigger Setting

Users can quickly set up to 40 automatic logic control functions, which can meet the automation control needs of most applications. It is automatically triggered according to preset conditions without human intervention, and the device automatically performs predetermined actions and notifies the user with text messages or network data. On the one hand, it saves time and reduces losses, on the other hand, it improves work efficiency.

For example: it can be set to automatically start the exhaust cooling equipment when the temperature is too high, and automatically shut down the exhaust cooling equipment when the temperature recovers, or start the diesel generator when the current and voltage are low, and stop the diesel

generator when the current and voltage are high, or turn off the water pump when the water pressure is high, start the water pump when the water pressure is low, and so on.

GSM 3G M2M RTU Configurator V3.4

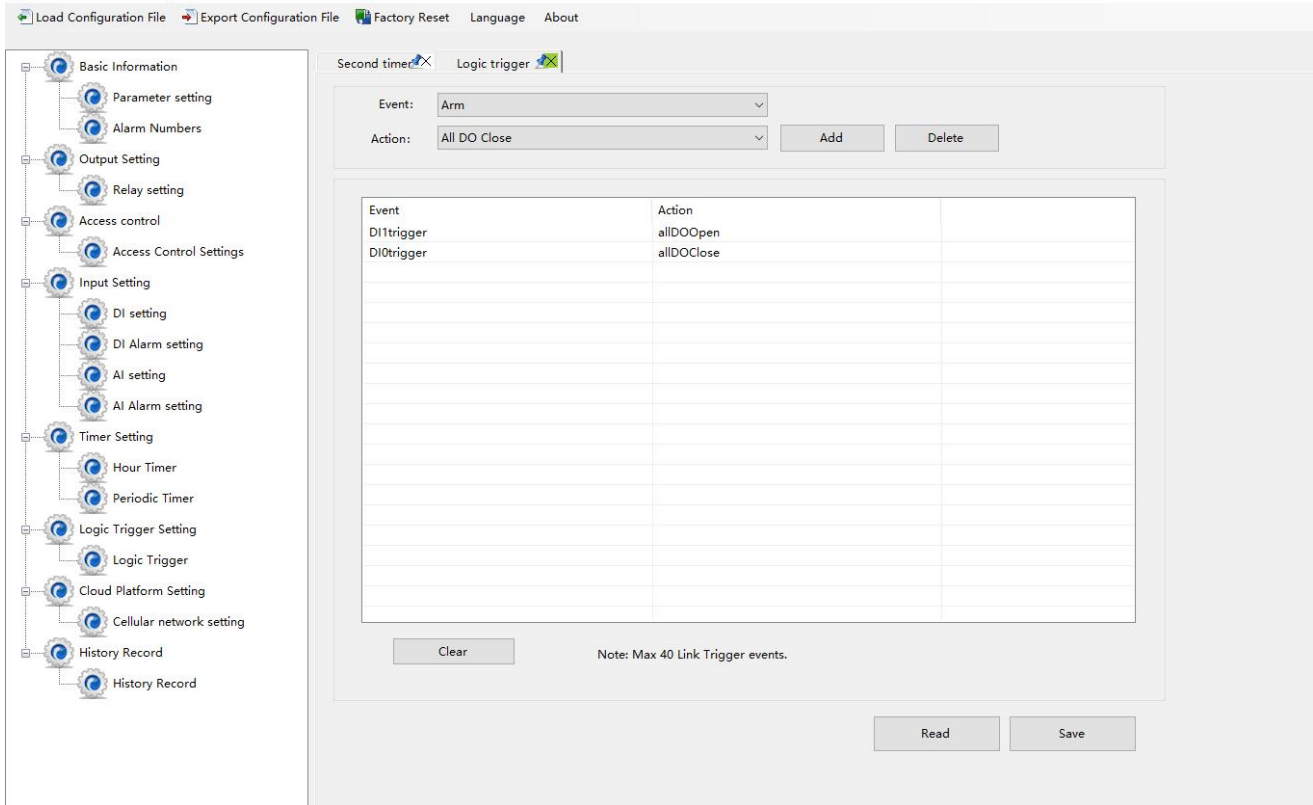

Logic trigger		
Item	Description	Default
Event	Including "Arm", "Disarm" "Dlx trigger", "Dlx recovery", "Dlx alarm of pulse interval", "Dlx alarm of total number of pulse", "Alx high alarm", "Alx low alarm", "Alx recovery", "Temperature high alarm", "Temperature low alarm", "Temperature recovery", "Humidity high alarm", "Humidity low alarm", "Humidity recovery"	--
Execute Action	Including "Reboot", "All DO close", "All DO open", "DO0 close", "DO0 open", "DO1 close", "DO1 open", "DO2 close", "DO2 open", "DO3 close", "DO3 open", "Open door", "Siren", "Arm", "Disarm", "GPRS online"	--
Add	Add selected settings	--
Delete	Delete selected settings	--

Note: "x" in "Dlx" means serial number of DI channel, "x" in "Alx" means serial number of AI channel.

4.9 Cellular Network Settings

If you want to use BLIIoT platform, please contact BLIIoT sales person to get Login message/Client ID.

Note:

- 1, Click the "Save" button to saving parameters in device;
- 2, When configuration is complete, power OFF the device;

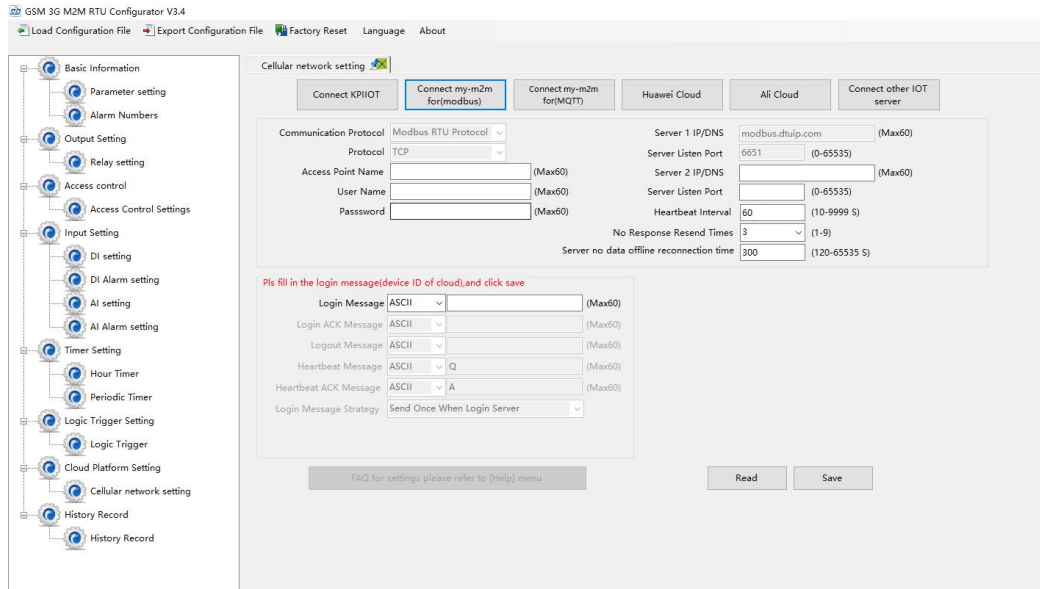

BLIIoT Cloud via Modbus		
Item	Description	Default
Communication protocol	When choosing BLIIoT cloud, the parameter is default	
Protocol	TCP	TCP
APN	Access point name provided by mobile operator	Empty
APN user name	User name provided by mobile operator	Empty
APN password	Password provided by mobile operator	Empty
Login message	Device serial number issued by BLIIoT (Contact sales to get the serial number)	Pay for cloud services
Login ACK message	System default	
Logout message	System default	
Heartbeat message	System default	
Heartbeat ACK message	System default	

Login message strategy	System default	Send once when login server
Server 1 IP/DNS	modbusrtu.kpiiot.com(BLIIoT V3.0 modbus) modbus.dtuip.com(BLIIoT V2.0 modbus)	Default
Server listen port	Target server 1 port number(BLIIoT V3.0 modbus)	4000
	Target server 1 port number(BLIIoT V2.0 modbus)	6651
Server 2 IP/DNS	Target server 2 DNS or IP	Empty
Server listen port	Target server 2 port number(0-65535)	Empty
Heartbeat interval	If the connection to the server fails 3 times in a row, the time interval for the next connection to the server.(1-9999) seconds	60
Resend time	After setting heartbeat and login message, if server no response, the times of data resend(1-9)	3

BLIIoT Cloud via MQTT		
Item	Description	Default
APN	Access point name provided by mobile operator	Empty
APN user name	User name provided by mobile operator	Empty
APN password	Password provided by mobile operator	Empty
Server 1 IP/DNS	mqtt.dtuip.com	Default
Server listen port	Target server 1 port number	1883
Server 2 IP/DNS	Target server 2 DNS or IP	Empty
Server listen port	Target server 2 port number(0-65535)	Empty
Subscribe topic	The topic when the device subscribes to the information /+	Automatically generate
Publish topic	The topic when the device publishes information	Automatically generate
MQTT Device ID	Device serial number issued by BLIIoT(Contact sales to get the serial number)	Pay for cloud services
MQTT user name	The account that publishes the topic on the proxy server	MQTT
MQTT password	The password to publish the topic on the	MQTTPW

	proxy server	
Publish period	The time interval for the device to upload data regularly (10-65535)	10
MQTT data re-transmission	Whether to enable data re-transmission	Enable/Disable

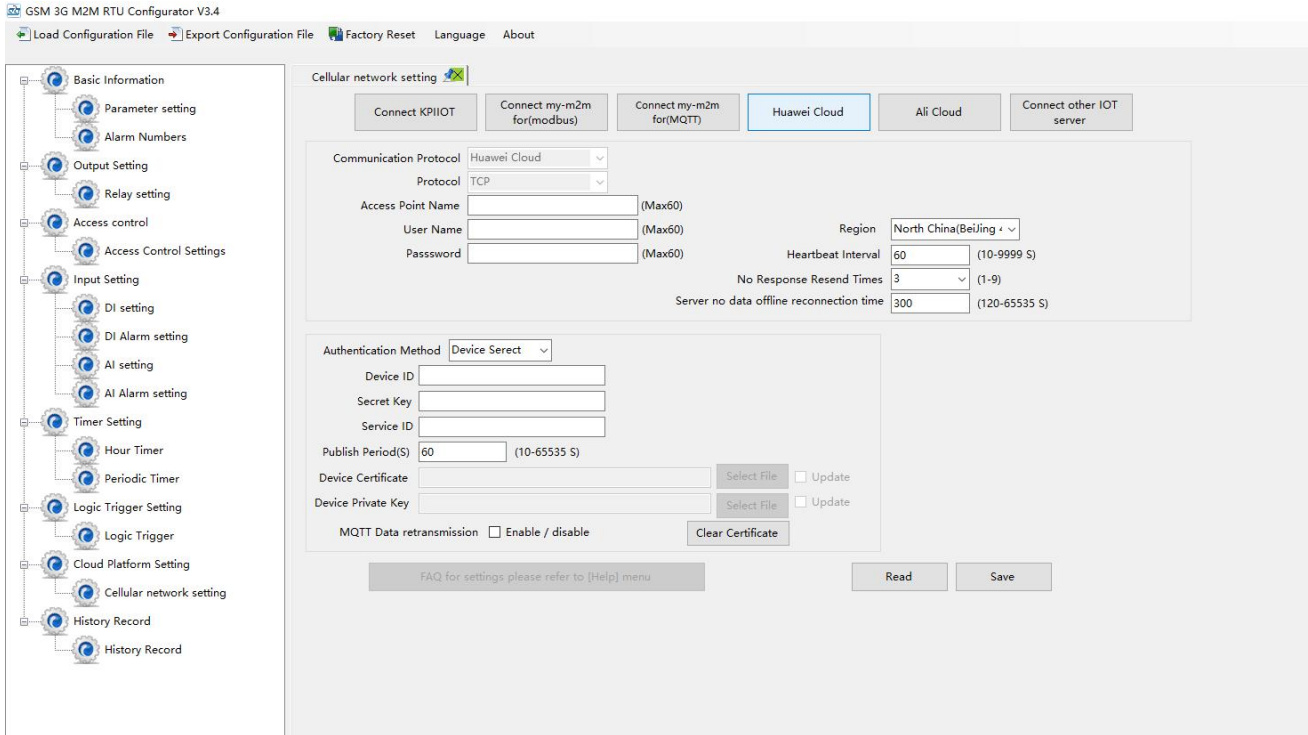

Huawei Cloud		
Item	Description	Default
APN	Access point name provided by mobile operator	Empty
APN user name	User name provided by mobile operator	Empty
APN password	Password provided by mobile operator	Empty
Authentication	Device key	Default
Device ID	Set the same ID as the one in HUAWEI Cloud(Device-Device ID)	Empty
Secret Key	Set the same Device Secret Key as the one in HUAWEI Cloud when creating device in HUAWEI Cloud.	Empty
Service ID	Set the same Service ID as the one in HUAWEI Cloud.	Empty
Publishing period	Cycle time of data publishing(10-65535)	60sec
MQTT data retransmission	Whether or not to enable data retransmission, check to enable.	Disable

Heartbeat time	The time interval between the next connection to the server after 3 consecutive failed connections to the server, in seconds.	60sec
Resend times	Number of times to resend data when there is no answer packet response (heartbeat packet answer and registration code answer packet are set). (1-9)	3

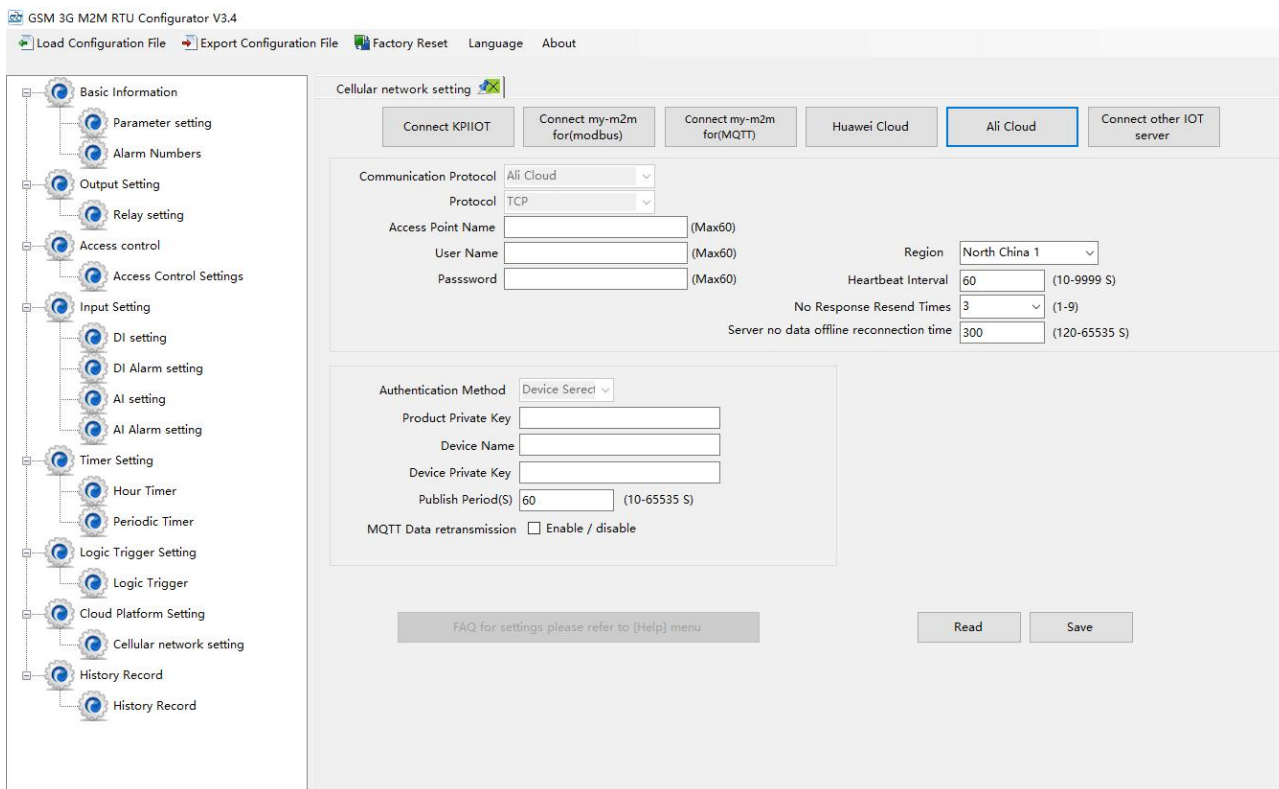

Ali Cloud		
Item	Description	Default
APN	Access point name provided by mobile operator	Empty
APN user name	User name provided by mobile operator	Empty
APN password	Password provided by mobile operator	Empty
Authentication	Device key	Default
Product private key	Set the same ProductKey as the one in Ali Cloud.(Device-Click DeviceSecret)	Empty
Device name	Set the same DeviceName as the one in Ali Cloud.(Device-Click DeviceSecret)	Empty
Device private key	Set the same DeviceSecret as the one in Ali Cloud(Device-Click DeviceSecret)	Empty
Publishing period	Cycle time of data publishing(10-65535)	60sec
MQTT data	Whether or not to enable data	Disable

retransmission	retransmission, check to enable.	
Heartbeat interval	The time interval between the next connection to the server after 3 consecutive failed connections to the server, in seconds.	60sec
Resend times	Number of times to resend data when there is no answer packet response (heartbeat packet answer and registration code answer packet are set). (1-9)	3

4.10 Historical Record

The device has a built-in 2M EEPROM, which is used to store the alarm records and historical records of the device. If you need the device to record historical records, then you need to set the interval for saving historical records in the [Periodic Timer] page, and alarm records do not need to be set separately, and the device will automatically save them.

The device will automatically manage the historical records. When there is no space in the memory, it will automatically delete the previous data and keep the latest half of the historical data. It is convenient for users to inquire. In addition, users can also export data to computers for permanent storage. Details as follows:

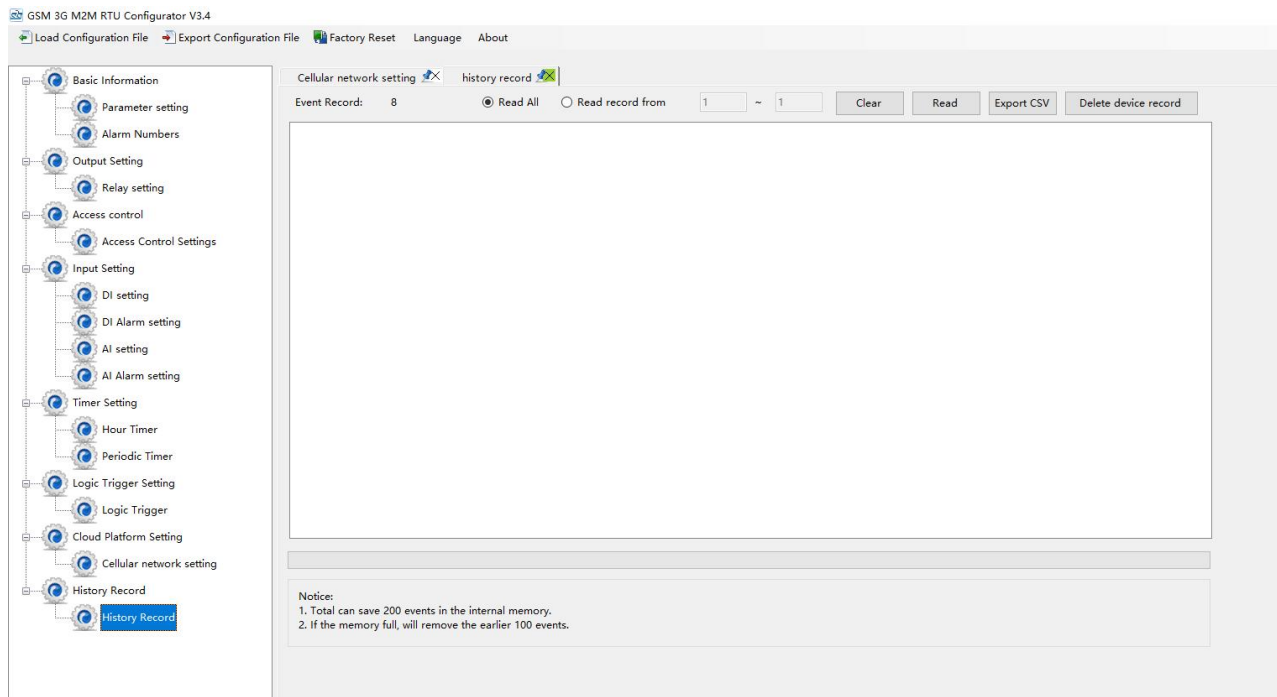

Historical Record		
Item	Description	Default
Event record	All records	--
Read all	Read all records in the device	Check
Read record from	Customize filtering of records	Uncheck

Clear	Clear the screen	Empty
Read	Read historical records	Empty
Save as CSV	Export to a CSV format file	--
Erase RTU records	Clear all the historical data	--

4.11 System

The same parameters can be quickly configured for multiple devices through the export and import function, and the factory reset function will restore the device to the factory settings.

 GSM 3G M2M RTU Configurator V3.4

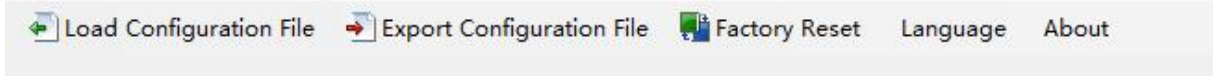

4.13.1 Export Configuration File

It is convenient for the user to save the configuration parameters of the device and configure multiple devices in batches.

4.13.2 Load Configuration File

Click Load Configuration File button at the top left of the page and select the file to load

4.14.3 Reset

Reset device through the factory reset button in configuration software.

All parameters of the device will be restored to the factory default initial value.

If you forget the password you set, please contact the after-sales service of Shenzhen Beilai Technology.

5 SMS Functions

This device supports remote setting, query, control and other operations through SMS commands.

Notes:

1. The default password is 1234, you can use SMS command to modify the password;
2. The "password" in the SMS command refers to the device password, such as 1234, just enter the password directly;

3. The "+" sign in the SMS command is not the content of SMS, please do not add any spaces or other characters in SMS;
4. SMS commands must distinguish between uppercase English letters, such as "PWD" instead of "pwd";
5. If the password is entered correctly and the command is entered incorrectly, the host will return a text message: "The command format is wrong, please confirm!" At this time, please check whether the Chinese and English input methods or uppercase and lowercase letters are correct;
6. If the password is entered incorrectly, no information will be returned;
7. The host will return a confirmation message after receiving the message command, if no message is returned, please check whether the password is correct and the signal is normal.

5.1 SMS Command List

1) Modify password

Event	SMS Command	Return SMS Content
Setting	Old Password+P+New Password	This is the New Password, please remember it carefully.

Default password: 1234, new password must be 4 digits

2) Arm/Disarm

Event	SMS Command	Return SMS Content
Arm	Password+AA	Armed
Disarm	Password+BB	Disarmed

3) Set RTU Time

Event	SMS Command	Return SMS Content
Setting	Password+Dxxxx-xx-xxTxx: xx: xxWxx For example: 1234D2015-05-22T15:20:30W01 W01 stands for Monday, W07 stands for Sunday	xxxx(Y)XX(M)XX(D)xx(H)X(M)xx(W)

4) Query Device Current State

Event	SMS Command	Return SMS Content
Query	Password+EE	Status: Armed/Disarmed: Model: Version: IMEI: GSM Signal Value:

5) Set User Numbers

Event	SMS Command	Return SMS Content
Setting	Password+A+series number+T+tel number Series number = 0~9	Tel: ---
Query	Password+A	Return all numbers
Delete	Password+A+series number	Return 0~4 or 5~9 numbers.

6) Call-in to open the door

Authorized number can dial to open the door

Event	SMS Command	Return SMS Content
Setting	<ul style="list-style-type: none"> ● Open door within the authorized time Password+B+series number+S+start time+E+end time ● Always have permission to open door Password+B+series number+P 	Tel1: --- Tel2: --- Tel3: 13570810254 Tel4: --- Tel5: ---
Query	Password+B	Return all authorized user numbers
Delete	Password+B+series number	Return all authorized user numbers

Example: "1234B0S201505231230E201605231230", where "201505231230" represents the year, month, day, hour and minute respectively.

7) Set Daily Report Time

Event	SMS Command	Return SMS Content
Setting	Password+DR+series number+T+time	Daily SMS Report at: xx:xx
Query	Password+DR	
Delete	Password+DRDEL	

Serial number: 0~9, example: "1234DR1T12:30"

8) Digital Input

Event	SMS Command	SMS Command
Query state	Password+DINE	DI1: Open/Close DI2: Open/Close -----

9) Analog Input

Event		SMS Command	SMS Command
Threshold	Setting	Password+AINR+channel number+Lxxx+Hxxx	Alx: Low:xxx, High:xxx.
	Query	Password+AINR+channel number	Alx: Low:xxx, High:xxx. Aly: Low:xxx, High:xxx.
	Delete	Password+AINR+channel number+DEL	
AI measurement range	Setting	Password+AINM+channel number+Lxxx+Hxxx	Alx: Min:xxx, Max:xxx
	Query	Password+AINM+channel number	Alx: Min:xxx, Max:xxx. Aly: Min:xxx, Max:xxx.
	Delete	Password+AINM+channel number+DEL	
Query current value		Password+AINR+channel number	AINx: xxxx , 【Normal/Higher/Lower】
Query all current value		Password+AINR	AIN1: xxxx , 【Normal/Higher/Lower】 AIN2: xxxx , 【Normal/Higher/Lower】 ----

You can query the value of multiple channels by enter several channel number

10) Control Relay

Event		SMS Command	Return SMS Content
DO Name	Setting	Password+DO+channel number+T	DOx:xxxx
	Query	Password+DO+channel number	DOx:xxxx
	Delete	Password+DO+ channel number+DEL	
Close Relay		Password+DOC+ channel number	DOx: Close DOy: Close
Open Relay		Password+DOO+ channel number	DOx: Open DOy: Open
Query current value		Password+DOE+ channel number	DOx: Close/Open DOy: Close/Open
Query all current value		Password+DOE	DO1: Close/Open DO2: Close/Open ---
Close relay according to		Password+DOLC+ channel number	DOx: DOy:

configured closing time			
Pulse output	Set time	Password+DOT+Time	Pulse Output Time: xxxS
	Query	Password+DOT	Pulse Output Time: xxxS
	Delete	Password+DOP+channel number	

11) Set Server (cellular network)

Event	SMS Command	Return SMS Content
Setting	Password+IP+ IP address+P+Com port	Sever: Port:
Query	Password+IP	
Delete	Password+IPDEL	

12) Set cellular network parameters

Event	SMS Command	Return SMS Content
Setting	Password+AP+apn+#+user name+#+user password	APN: User name: Password
Query	Password+AP	
Delete	Password+APDEL	

13) GPRS Online

Event	SMS Command	Return SMS Content
Online	Password+GPRSonline	GPRS always online

14) Historical Data

Event	SMS Command	Return SMS Content
Delete	Password+HISDEL	Delete all historical records

15) Set pulse counter

Event	SMS Command	Return SMS Content
Clear	Password+DIN+Channel number+CLR	Clear Successfully
Query	Password+PR	Counter Current Value: xxx

Channel number is 0~3, corresponding to DI0~3 pulse counter

6 Communication Protocols

S271 can be connected to servers, SCADA or cloud platform via 4G.

Make sure mobile phone communication is normal

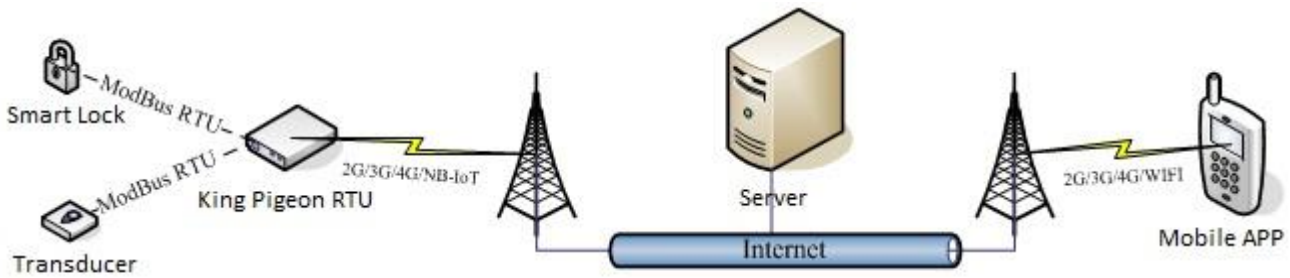

[Refer to chapter 4.1 Preparation before configuration](#)

- 1, Open configuration software to log in.
- 2, On parameter page, click "Sync RTU time", "Read RTU time" to set up time synchronization.
- 3, Check arm automatically when power on.
- 4, Click the "Save" button to saving parameters in device.
- 5, On alarm numbers page, enter the mobile phone number used to receive the alarm, and then check the corresponding options, if you want to receive text messages from device power on, power lost, and power recovery, check the power on, power lost, power recovery, then click the [Save] button.

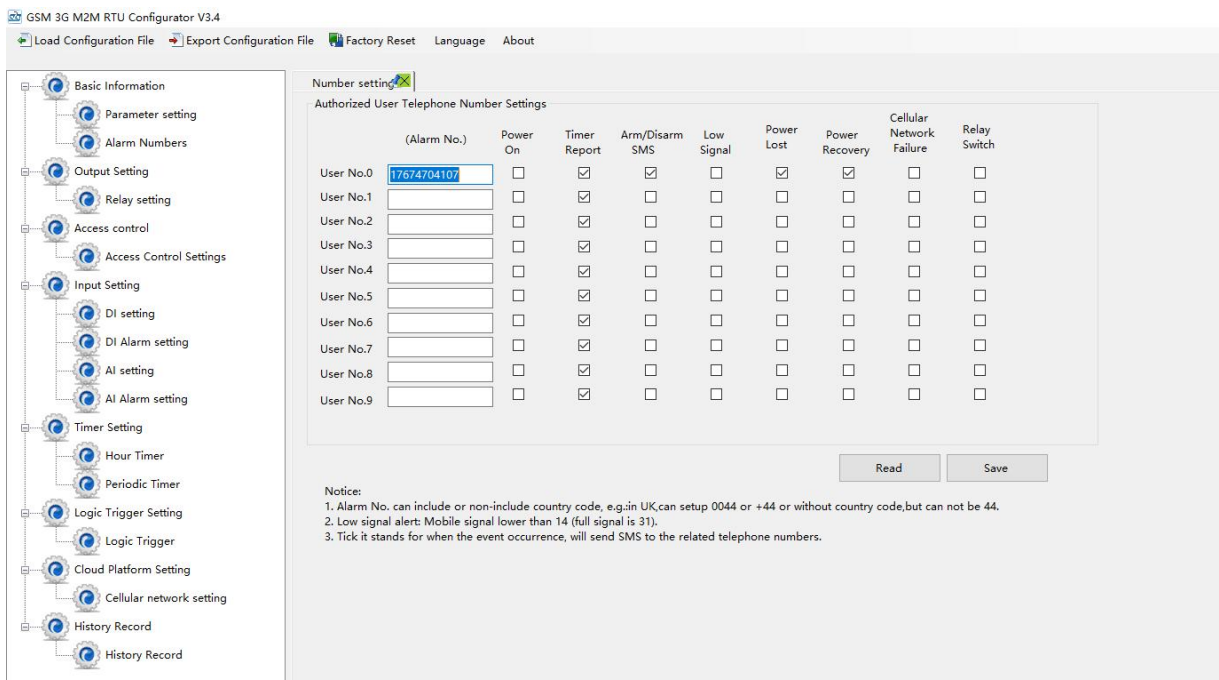

6, Power OFF the device. switch DIP switch on device to [RUN] mode.

7, Install the SIM card, and then turn on the device, wait for about 1-2 minutes, the number used to receive the alarm should receive message notify the device is turned on. Unplug the external power supply of the device, the number used to receive the alarm should receive message notify the external power lost. Then re-connect the external power supply to the device, then the mobile phone number used to receive the alarm should receive message notify the external power recovery. So far, it has been verified that the device can communicate normally.

8, Power off the device, reboot device, and enter the configuration page again. Click [Read] button on the page, read the previously set parameters first, otherwise it will be overwritten by the new parameters.

6.1 Modbus RTU Slave Application

6.1.1 Read DO State

Relay DO register address as holding coil, address 0~3, [refer to chapter 8 Device Register Address](#)

Master Send Data Format:

Content	Bytes	Data (H: HEX)	Description
Device Address	1	01H	01H Device, Range: 1-247, according to setting address
Function Code	1	01H	Read holding coil type, function code 01
DO Register start address	2	00 00H	Range: 0000H-0003H
Read DO Register QTY	2	00 04H	Range: 0001H-0004H
16CRC Verify	2	3D C9H	CRC0 CRC1 low byte in front, high byte in behind

Receiver Return Data Format:

Content	Bytes	Data (H: HEX)	Description
Device Address	1	01H	01H Device, according to the data Master send
Function Code	1	01H	Read holding coil
Return Byte Length	1	01H	Return Data Length

Returning Data	1	02H	02H means 4 DO status, high 4 byte invalid, low 4 Byte converter Binary as below			
			DO3(bit3)	DO2(bit2)	DO1(bit1)	DO0(bit0)
			0	0	1	0
			Open	Open	Close	Open
			Device current relay status: DO0,DO2,DO3 = Open, DO1= Close			
16CRC Verify	2	D0 49H	CRC0 CRC1 low byte in front, high byte in behind			

Example: Read 4 relays DO0~DO3 status, device address as 1 :

Server send: 01 01 00 00 00 04 3D C9

01H= Device address; 01H= Read relay function code; 00 00H= Read starting relay DO0 address; 00 04H= Read serial 4 DO status; 3D C9H CRC= Verify.

Device answer: 01 01 01 02 D0 49

01H= Device address; 01H= Read relay function code; 01H= Return data byte qty; 02H= Returning data, stands for Binary 0000 0010 high 4 byte invalid, low 4 byte 0010, sort as DO3 DO2 DO1 DO0 status, D0 49HCRC verify.

If read DO or multi DO status, only need to revise DO Register start address and Read DO Register QTY , calculate the CRC again, returning data according to description data.

6.1.2 Control DO

1) Control 1 channel device DO output

Master Send Data Format:

Content	Bytes	Data (H: HEX)	Description
Device Address	1	01H	01H Device, Range: 1-247, according to setting address
Function Code	1	05H	Write single holding coil type, function code 05
DO Register Address	2	00 00H	Range: 0000H-0003H, stands for DO0-DO3
Active	2	FF 00H	This value: FF 00H or 00 00H, FF 00H= Close relay, 00 00H= Open relay
16CRC Verify	2	8C 3AH	CRC0 CRC1 low byte in front, high byte in behind

Receiver Return Data Format:

Content	Bytes	Data	Description
---------	-------	------	-------------

		(H: HEX)	
Device Address	1	01H	01H Device, according to the data Master send
Function Code	1	05H	Write single holding coil type, function code 05
DO Register Address	2	00 00H	Range: 0000H-0003H, stands for DO0-DO3
Active	2	FF 00H	This value: FF 00H or 00 00H, FF 00H= Already actived close relay, 00 00H= Already actived open relay
16CRC Verify	2	8C 3AH	CRC0 CRC1 low byte in front, high byte in behind

Example: Control relay DO0 close, then:

Server send: 01 05 00 00 FF 00 8C 3A

01H= Device address; 05H= Control single relay command; 00 00H = Address of DO0; FF 00H= DO0 close;

8C 3A H16 byte CRC verify.

Device answer: 01 05 00 00 FF 00 8C 3A

01H= Device address; 05H= Control single relay command; 00 00 H = DO0 Address; FF 00H= Active DO0 close; 8C 3AH 16 byte CRC verify.

If single control other relay outputs, only need to change DO Register Address and Active, calculate CRC verify again.

2) Multi control DO outputs

Master Send Data Format:

Content	Bytes	Data (H: HEX)	Description												
Device Address	1	01H	01H Device, according to setting address												
Function Code	1	0FH	Write multi holding coil, function code 15												
DO Register start address	2	00 00H	Range: 0000H-0003H, stands for DO0-DO3												
Control Relay Qty	2	00 04H	Range: 00001H-0004H												
Write Byte QTY	1	01H	Write 1 byte, since device only 4DO, use 4 binary can do it												
Writing Data	1	0FH	0FH stands for 4 DO status, high 4 byte invalid, low 4 byte converter to binary as below <table border="1" style="margin: 5px auto; width: 80%;"> <thead> <tr> <th>DO3(bit3)</th> <th>DO2(bit2)</th> <th>DO1(bit1)</th> <th>DO0(bit0)</th> </tr> </thead> <tbody> <tr> <td style="text-align: center;">1</td> <td style="text-align: center;">1</td> <td style="text-align: center;">1</td> <td style="text-align: center;">1</td> </tr> <tr> <td style="text-align: center;">Active close</td> <td style="text-align: center;">Active close</td> <td style="text-align: center;">Active close</td> <td style="text-align: center;">Active close</td> </tr> </tbody> </table> 1= Active close, 0= Active open	DO3(bit3)	DO2(bit2)	DO1(bit1)	DO0(bit0)	1	1	1	1	Active close	Active close	Active close	Active close
DO3(bit3)	DO2(bit2)	DO1(bit1)	DO0(bit0)												
1	1	1	1												
Active close	Active close	Active close	Active close												
16CRC Verify	2	7E 92H	CRC0 CRC1 low byte in front, high byte in behind												

Receiver Return Data Format:

Content	Bytes	Data	Description
---------	-------	------	-------------

		(H: HEX)	
Device Address	1	01H	01H Device, according to setting address
Function Code	1	0FH	Write multi holding coil
DO Register start address	1	00 00H	Range: 0000H-0003H, stands for DO0-DO3
Active Relay Qty	1	00 04H	Qty: 0-4, stands for how many relays already activated
16CRC Verify	2	54 08H	CRC0 CRC1 low byte in front, high byte in behind

Example: Close device 4 DO at same time, then:

Server send: 01 0F 00 00 00 04 01 0F 7E 92

01H= Device address; 0FH= Control multi relay; 00 00H= Relay DO0 starting address; 00 04H= Control 4 relays; 01H= Send data qty; 0FH= Data sent converter to binary 0000 1111 high 4 byte invalid, low 4 byte 1111 sort to match DO3 DO2 DO1 DO0, 1 stands for close relay, 7E 92H CRC verify.

Device answer: 01 0F 00 00 00 04 54 08

01H= Device address; 0FH= Control multi relay; 00 00H= Relay DO0 starting address; 00 04H= Activated 4 relays; 54 08H CRC verify.

6.1.3 Read DI State

Master Send Data Format:

Content	Bytes	Data (H: HEX)	Description
Device Address	1	01H	01H Device, Range: 1-247, according to setting address
Function Code	1	02H	02 read input coil DIN status
DIN Register Start Address	2	00 00H	Range: 0000H-0003H, stands for DIN0-DIN3
Read DIN Register Qty	2	00 04H	Range: 0001H-0004H, Read qty of DIN status
16CRC Verify	2	79 C9H	CRC0 CRC1 low byte in front, high byte in behind

Receiver Return Data Format:

Content	Bytes	Data (H: HEX)	Description
Device Address	1	01H	01H Device, Range: 1-247, according to setting address
Function Code	1	02H	02 read input coil DIN status
Return Bytes Qty	1	01H	Return Data Length

Returning Data	1	0FH	<p>0FH converter to binary 0000 1111 from high to low byte, stands for DIN4-DIN0 status</p> <table border="1" style="margin-left: auto; margin-right: auto;"> <tr> <td>DIN3</td> <td>DIN2</td> <td>DIN1</td> <td>DIN0</td> </tr> <tr> <td>1</td> <td>1</td> <td>1</td> <td>1</td> </tr> <tr> <td>Close</td> <td>Close</td> <td>Close</td> <td>Close</td> </tr> </table> <p>1= Close, 0= Open</p>	DIN3	DIN2	DIN1	DIN0	1	1	1	1	Close	Close	Close	Close
DIN3	DIN2	DIN1	DIN0												
1	1	1	1												
Close	Close	Close	Close												
16CRC Verify	2	E1 8CH	CRC0 CRC1 low byte in front, high byte in behind												

Example: Inquiry device 4 DIN data at same time, then:

Server send: 01 02 00 00 00 04 79 C9

01H= Device address; 02H= Inquiry DIN status; 00 00H= DI Starting address; 00 04H= Serial reading 4 DIN status; 79 C9 H CRC verify.

Device answer: 01 02 01 0F E1 8C

01H= Device address; 02H= Inquiry DIN status; 01H= Returning data bytes qty; 0FH DIN status, every byte stands for one DIN status, 0FH converter to binary 0000 1111 from high to low byte, stands for DIN4-DIN0 status, 0= Open, 1= Close, E1 8CH 16 byte CRC verify.

If need to inquiry multi DIN status, only need to change DIN Register Start Address, Read DIN Register Qty, calculate CRC verify again.

6.1.4 Read AI, Tem&Hum, DI0, Power value

Master Send Data Format:

Content	Bytes	Data (H: HEX)	Description
Device Address	1	01H	01H Device, Range: 1-247, according to setting address
Function Code	1	04H	04 read input register
Register Starting Address	2	00 00H	Register Starting Address
Read Register Qty	2	00 1CH	Read qty of input register, total 28 16bit register
16CRC Verify	2	F1 C3H	CRC0 CRC1 low byte in front, high byte in behind

Receiver Return Data Format:

Content	Bytes	Data (H: HEX)	Description																												
Device Address	1	01H	01H Device, Range: 1-247, according to setting address																												
Function Code	1	04H	04 read input register																												
Return Bytes Qty	1	04H	Return Data Length																												
Returning Data	38	00 00 00 E7 00 00 00 DD 00 00 00 DD 00 00 00 DC 00 00 00 DE 00 00 00 DF 00 00 00 00 04 C6 01 9A 00 00 00 01 00 01 00 01 00 01 00 01 00 01 00 01 0B 36 1B E4 00 00 00 0B	N= Returning bytes, sample data 56 points:																												
			<table border="1" style="width: 100%; border-collapse: collapse;"> <thead> <tr> <th style="width: 10%;">AIN</th> <th style="width: 10%;">AIN0</th> <th style="width: 10%;">AIN1</th> <th style="width: 10%;">AIN2</th> <th style="width: 10%;">AIN3</th> <th style="width: 10%;">Reserv ed</th> <th style="width: 10%;">Reserv ed</th> </tr> </thead> <tbody> <tr> <td>Receivin g Data</td> <td>00 00 00 E7</td> <td>00 00 00 DD</td> <td>00 00 00 DD</td> <td>00 00 00 DC</td> <td>00 00 00 DE</td> <td>00 00 00 DF</td> </tr> <tr> <td>Decimal Value</td> <td>194</td> <td>207</td> <td>0</td> <td>0</td> <td>0</td> <td>0</td> </tr> <tr> <td>Real Value</td> <td>1.94</td> <td>2.07</td> <td>0</td> <td>0</td> <td>0</td> <td>0</td> </tr> </tbody> </table>	AIN	AIN0	AIN1	AIN2	AIN3	Reserv ed	Reserv ed	Receivin g Data	00 00 00 E7	00 00 00 DD	00 00 00 DD	00 00 00 DC	00 00 00 DE	00 00 00 DF	Decimal Value	194	207	0	0	0	0	Real Value	1.94	2.07	0	0	0	0
			AIN	AIN0	AIN1	AIN2	AIN3	Reserv ed	Reserv ed																						
			Receivin g Data	00 00 00 E7	00 00 00 DD	00 00 00 DD	00 00 00 DC	00 00 00 DE	00 00 00 DF																						
			Decimal Value	194	207	0	0	0	0																						
			Real Value	1.94	2.07	0	0	0	0																						
			<table border="1" style="width: 100%; border-collapse: collapse;"> <thead> <tr> <th style="width: 10%;">Other Value</th> <th style="width: 15%;">External Power Voltage</th> <th style="width: 15%;">Temperatur e</th> <th style="width: 15%;">Humidity</th> <th style="width: 15%;">DIN0 Count Value</th> </tr> </thead> <tbody> <tr> <td>Receivin g Data</td> <td>04 C6</td> <td>0B 36</td> <td>1B E4</td> <td>00 00 00 0B</td> </tr> <tr> <td>Decimal Value</td> <td>1222</td> <td>2870</td> <td>7140</td> <td>11</td> </tr> <tr> <td>Real Value</td> <td>12.22V</td> <td>28.7°C</td> <td>71.4%RH</td> <td>11 times</td> </tr> </tbody> </table>	Other Value	External Power Voltage	Temperatur e	Humidity	DIN0 Count Value	Receivin g Data	04 C6	0B 36	1B E4	00 00 00 0B	Decimal Value	1222	2870	7140	11	Real Value	12.22V	28.7°C	71.4%RH	11 times								
			Other Value	External Power Voltage	Temperatur e	Humidity	DIN0 Count Value																								
			Receivin g Data	04 C6	0B 36	1B E4	00 00 00 0B																								
			Decimal Value	1222	2870	7140	11																								
Real Value	12.22V	28.7°C	71.4%RH	11 times																											
AIN, External Power Voltage, Temperature, Humidity real value=Register value/100																															
16CRC Verify	2	A9 3CH	CRC0 CRC1 low byte in front, high byte in behind																												

Example: Inquiry device 4 AIN, temperature, humidity, external power voltage, DIN0 count value, then:

Server send: 01 04 00 00 00 1C F1 C3

01H= Device address; 04H= Read input register value; 00 00H= Starting address; 00 1CH= Serial reading 28 input register value; F1 C3H CRC verify.

Device answer: 01 04 38 00 00 00 E7 00 00 00 DD 00 00 00 DD 00 00 00 DC 00 00 00 DE 00 00 00 DF 00 00 00 00 04 C6 01 9A 00 00 00 01 00 01 00 01 00 01 00 01 00 01 00 01 00 01 0B 36 1B E4 00 00 00 0B A9 3C

01H= Device address; 04H= Read input register value; 38H=Return data length,
 00 00 00 E7H 00 00 00 DD 00 00 00 DD 00 00 00 DC 00 00 00 DE 00 00 00 DF 00 00 00 00 04 C6
 01 9A 00 00 00 01 00 01 00 01 00 01 00 01 00 01 0B 36 1B E4 00 00 00 0B

7 Connect to Cloud Platform

7.1 BLIIoT Modbus Cloud

1) Enter "Login message" then click "Save"

Please contact sales person to get Login message

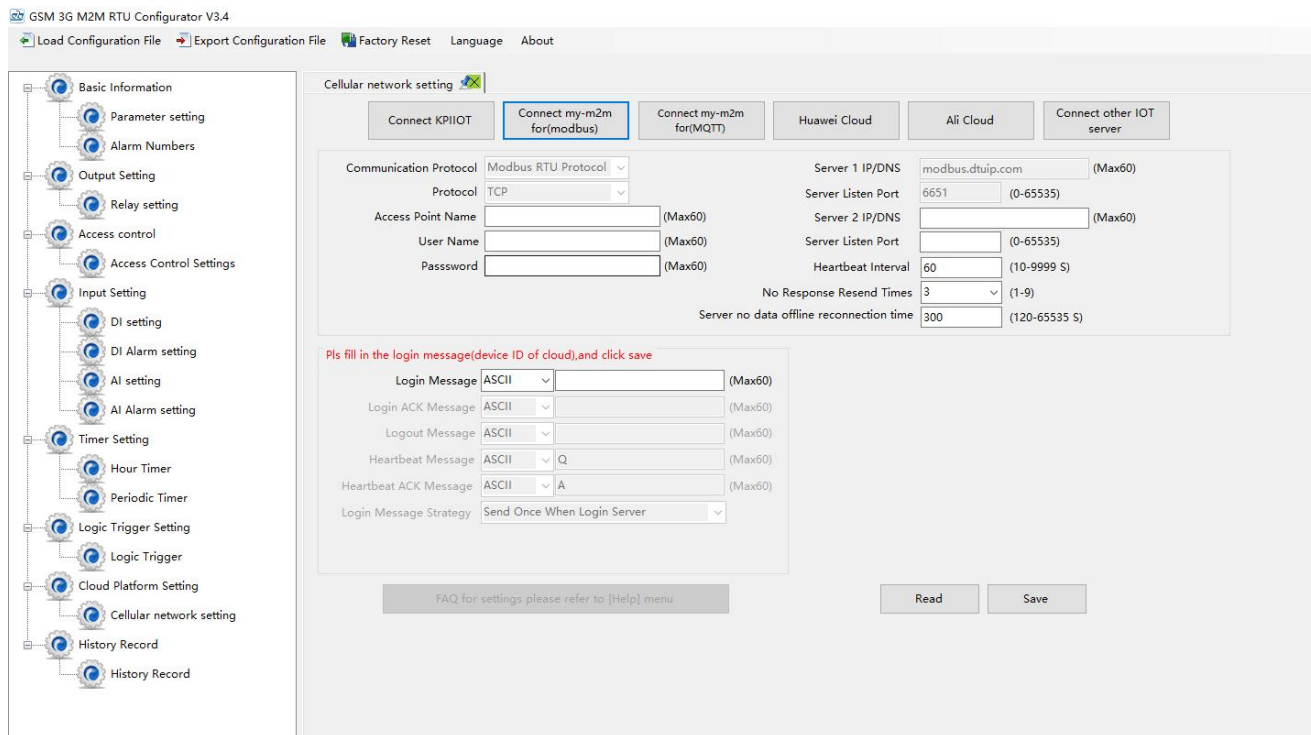

2) Add data points BLIIoT cloud(Data point identification REGXXX refer to chapter 8 Device Register Address)

M2M Monitoring Center

Device List

Device:

Equipment:

Device:

Link:

time zone:

Dropping:

Sensor:

Read write instruction settings

Serial Number	Sensor	Slave Address	Function Code	Bias	Data Format	Data Bits	Byte Order	Acquisition Cycle
1	DO0	1	01Read and write	1	bit			60
2	DO1	1	01Read and write	2	bit			60
3	DIN0	1	02Read-only	1	bit			60
4	DIN1	1	02Read-only	2	bit			60
5	AIN0	1	04Read-only	1	32Position Signed N		AB CD	60
6	AIN1	1	04Read-only	3	32Position Signed N		AB CD	60
7	温度	1	04Read-only	25	16Position Signed N			60
8	湿度	1	04Read-only	26	16Position Signed N			60
9	DIN0计数	1	04Read-only	27	32Position Unsigned		AB CD	60
10	电压电源	1	04Read-only	15	16Position Unsigned			60

➤ Slave address: S27X ID

- Function code: Select the corresponding function code according to the slave type(Refer to chapter 8 Device Register Address)
- Bias: The register address of S27X needs to plus 1, such as address 0 bias item enter 1
- Data format: The Boolean type does not need to be set, and the numerical type is selected according to the actual situation.
- Byte order:Sorting of numerical data points
- Acquisition cycle: Interval time of data acquisition

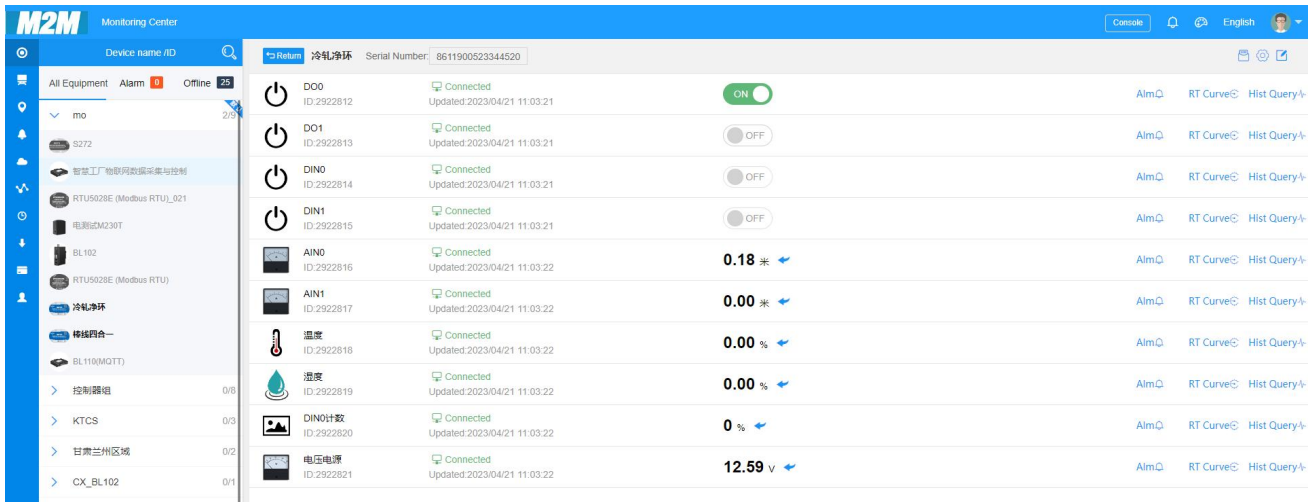

7.2 BLIIoT MQTT Cloud

There are three kinds of identities in the MQTT protocol: Publisher (Publish), Broker (Broker) (server), and Subscriber (Subscribe). Among them, the publisher and subscriber are both clients, the broker is server, and the message publisher can also be a subscriber. Take S27X connected to BLIIoT cloud 2.0 platform as an example:

When device publish I/O point data:

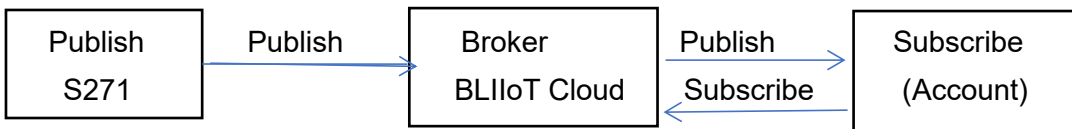

When customer control the device:

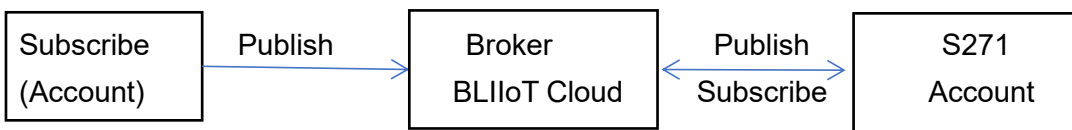

Enter MQTT device ID

GSM 3G M2M RTU Configurator V3.4

Load Configuration File | Export Configuration File | Factory Reset | Language | About

Cellular network setting

Communication Protocol: MQTT Protocol
 Protocol: TCP
 Access Point Name: _____ (Max60)
 User Name: _____ (Max60)
 Password: _____ (Max60)

Server 1 IP/DNS: mqtt.dtuip.com (Max60)
 Server Listen Port: 1883 (0-65535)
 Server 2 IP/DNS: _____ (Max60)
 Server Listen Port: _____ (0-65535)
 Heartbeat Interval: 60 (10-9999 S)
 No Response Resend Times: 3 (1-9)
 Server no data offline reconnection time: 300 (120-65535 S)

Subscribe Topic: _____
 Publish Topic: _____
 MQTT Client ID: _____
 MQTT User Name: MQTT
 MQTT Password: MQTTPW
 Publish Period(S): 60 (10-65535 S)
 MQTT Data retransmission Enable / disable
 Tips: Only use MQTT Protocol require to setup.

FAQ for settings please refer to [Help] menu

Add data points on BLIIoT cloud

M2M Monitoring Center

Device List

Device: mo

Equipment: Equipment translation serial number

Device: Please enter the device name

Link: MQTT

time zone: UTC+08:00

Dropping: Recommended Value | 60 (seconds)

Sensor:

❖ Payload data format of device publish message

Publish Topic: MQTT client ID

```

{
  "sensorDatas": [
    {
      "flag": "DO1",          //Read and write flag
      "switcher": 1         //data type and value
    },
    {
      "flag": "AI1",
      "value": 10.00
    }
  ],
  "time": "1591841863",     //Time stamp
  "state": "alarm",        //Alarm(Only appears when alarm occurs)
  "state": "recovery",    //Alarm(Only appears when alarm recover)
  "retransmit": "enable"  //Historical data (only for re-transmission of
  historical data, but not for real-time data)
}

```

Note:

//Read and write flag: the character is "flag", followed by "MQTT identification of data points"

//Data type and value:

1. Switch-type data: the character is "switcher", followed by "0" or "1" (0 open, 1 closed)
2. Numerical data: the character is "value", followed by "specific value"

//Timestamp: the character is "time", followed by "specific timestamp "

//Alarm and recovery identification: the characters are "state", followed by "alarm" or "recovery"
(alarm is alarm data, recovery is recovery data)

//Historical data identification: the character is "retransmit", followed by "enable"

The data collected during the network disconnection will be temporarily stored in the device, and will be republished when the network is recovered. It is identified by the "retransmit" character, indicating historical data. (Need to enable MQTT data retransmission function in the configuration software)

❖ Payload data format in device subscription message

(The topic of the BLIIoT 2.0 platform downstream publish message is called "device serial number/sensor ID", so the device subscribe topic needs to add the wildcard "/"+" in order to receive the data sent by the platform to achieve control)Subscribe topic: device serial number /+ (corresponding to the data filled in the subscribe topic item on the configuration software)

```
{
```

```

"sensorDatas":
[
  {
    "sensorsId": 211267, //platform sensor ID
    "switcher":1,      //data type :value
    "flag":"DO1"      // Read and write flag
  }
],
"down":"down"        //Platform downstream packet identification
}

```

Note:

//Platform sensor ID: The character is "sensorsID", followed by the ID number (ID is automatically generated by the platform)

//Data type and value:

1. Switch-type data: The character is "switcher", followed by "0" or "1" (0 open, 1 closed)
2. Numerical data: The character is "value", followed by "specific value"

//Read and write flag: The character is "flag", followed by "MQTT identification of data points"

//Downstream packet identification of the platform: The character is "down", followed by "down", which means that this is the downlink data of the platform.

Device I/O data point read and write flag

Data Point	Flag	Type	Description
DO	DOx	Switcher	0 is open, 1 is closed
DI	Dix	Switcher	0 is open, 1 is closed
AI	Aix	Value	True value = original value
Temperature	TEMP	Value	True value = original value
Humidity	HUMI	Value	True value = original value
External power voltage	EXTPWR	Value	True value = original value
DIN0 counter	COUNT	Value	True value = original value
DIN1counter	COUNT1	Value	True value = original value
DIN2 counter	COUNT2	Value	True value = original value
DIN3 counter	COUNT3	Value	True value = original value

Note:

“DOx”: DO0, DO1, DO2, DO3

“Dix”: DI0, DI1, DI2, DI3

“Aix”: AI0, AI1, AI2, AI3

7.3 Huawei Cloud

Firstly, create a device on HUAWEI CLOUD to obtain the device ID, device secret, service ID.

1, Create Product

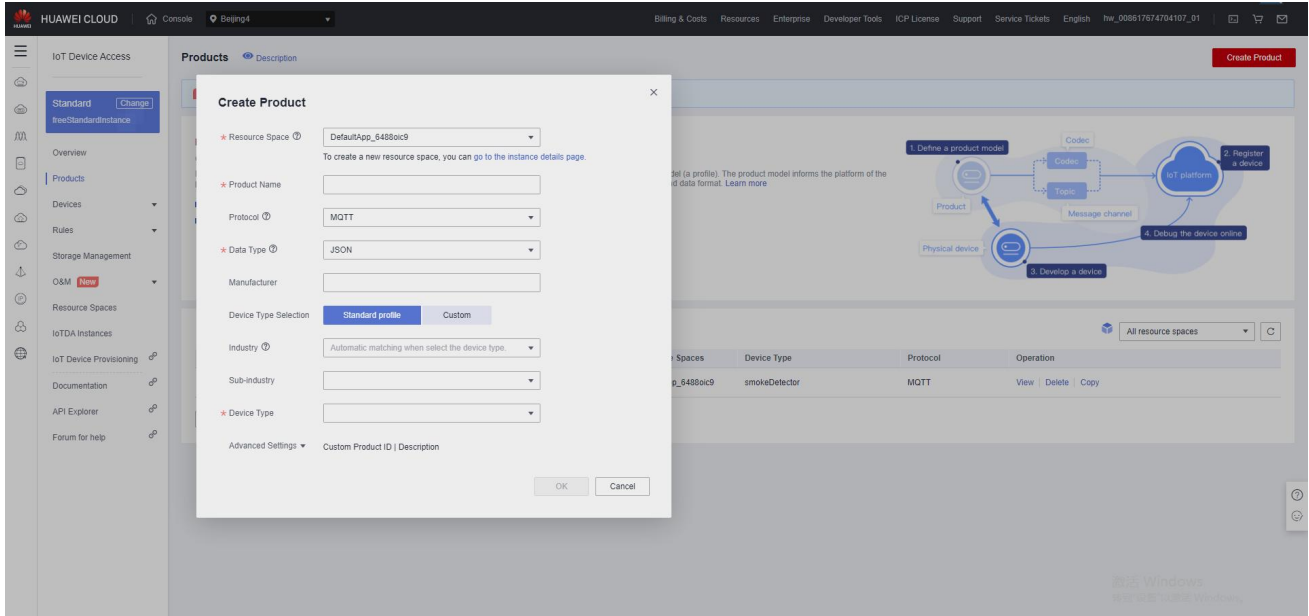

2, Individual Register

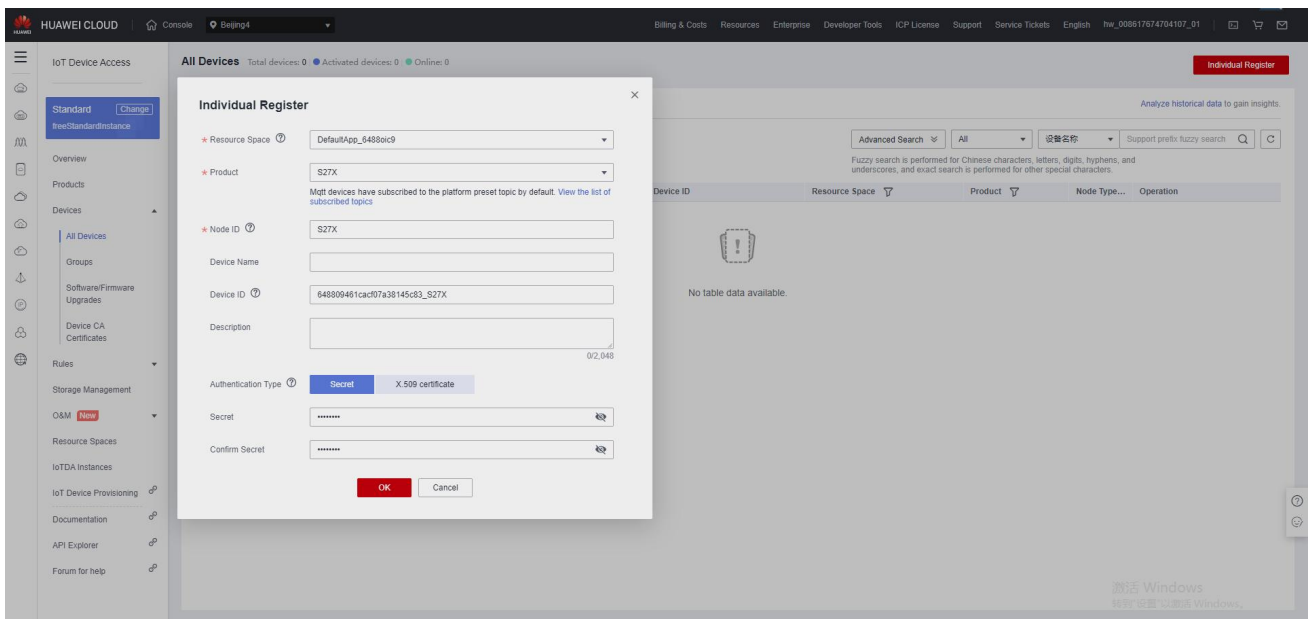

3, Obtain the device ID, device secret, service ID

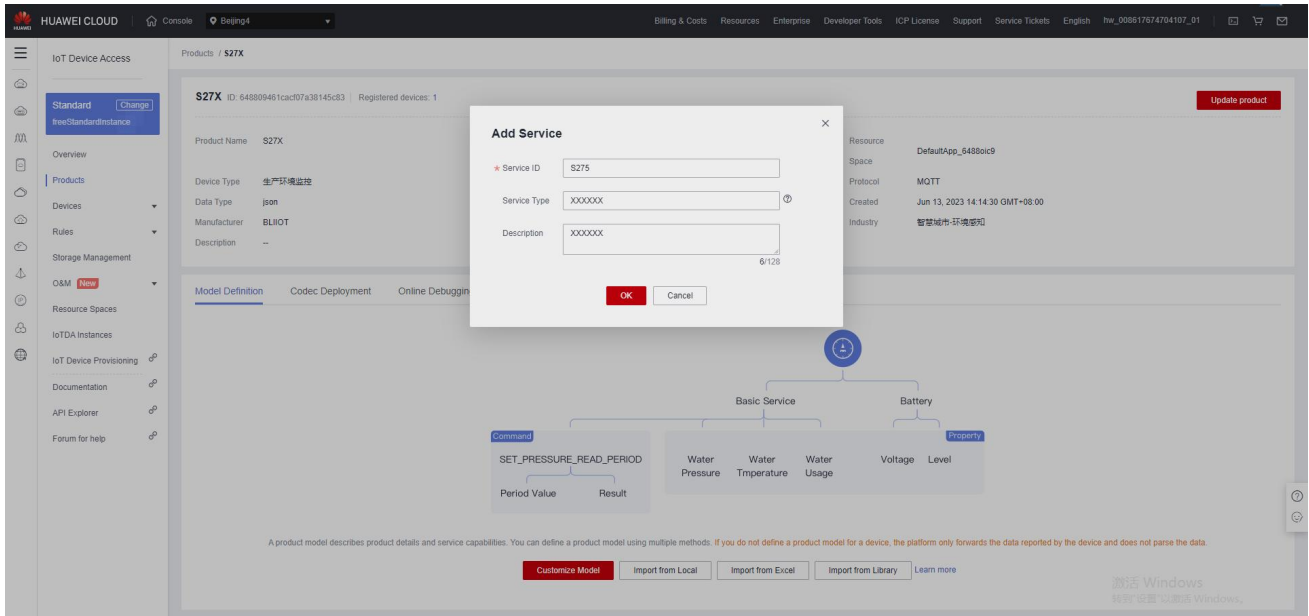
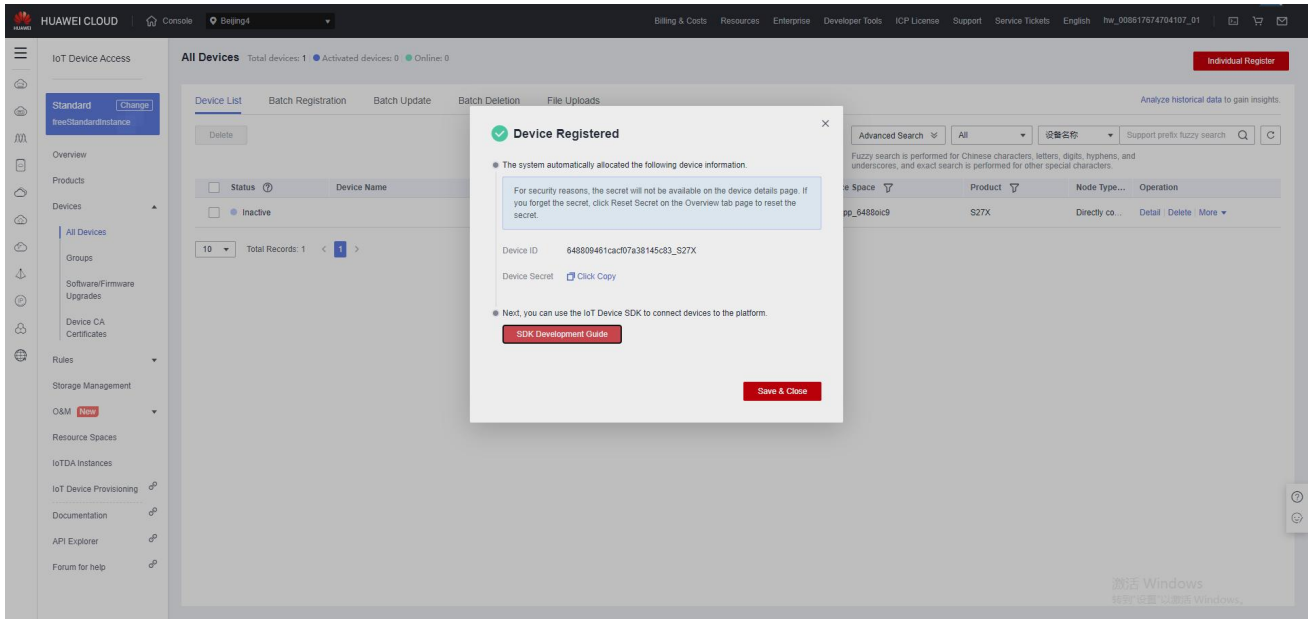

4, Add Property

Property name refer to chapter 8 Device Register Address

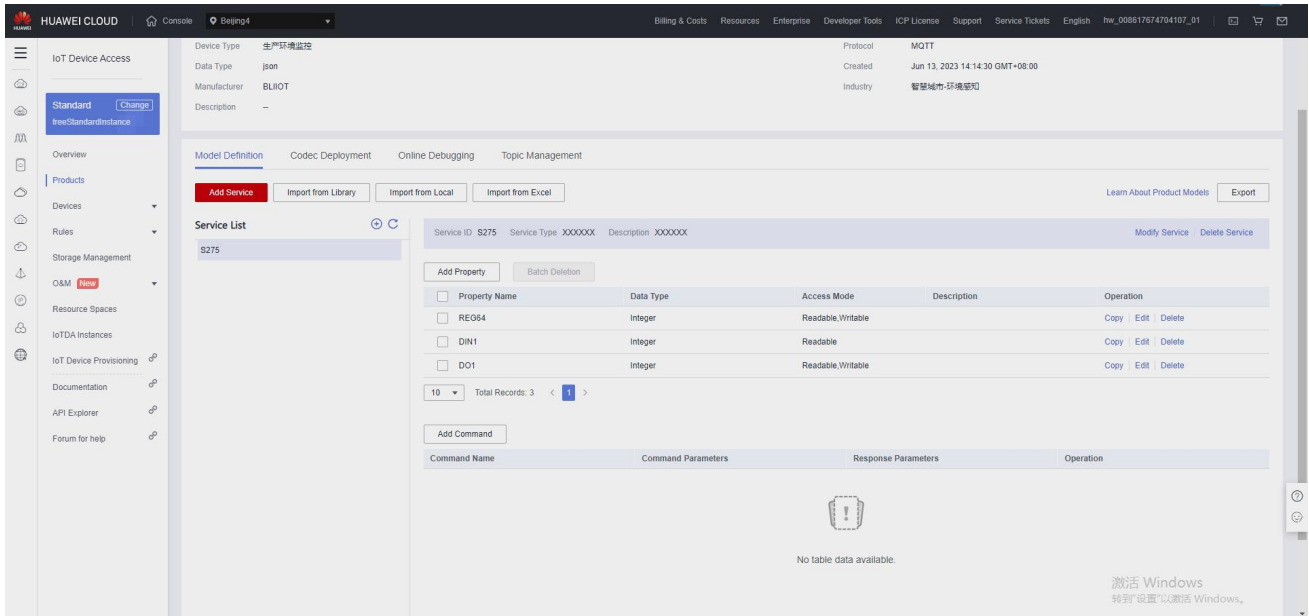
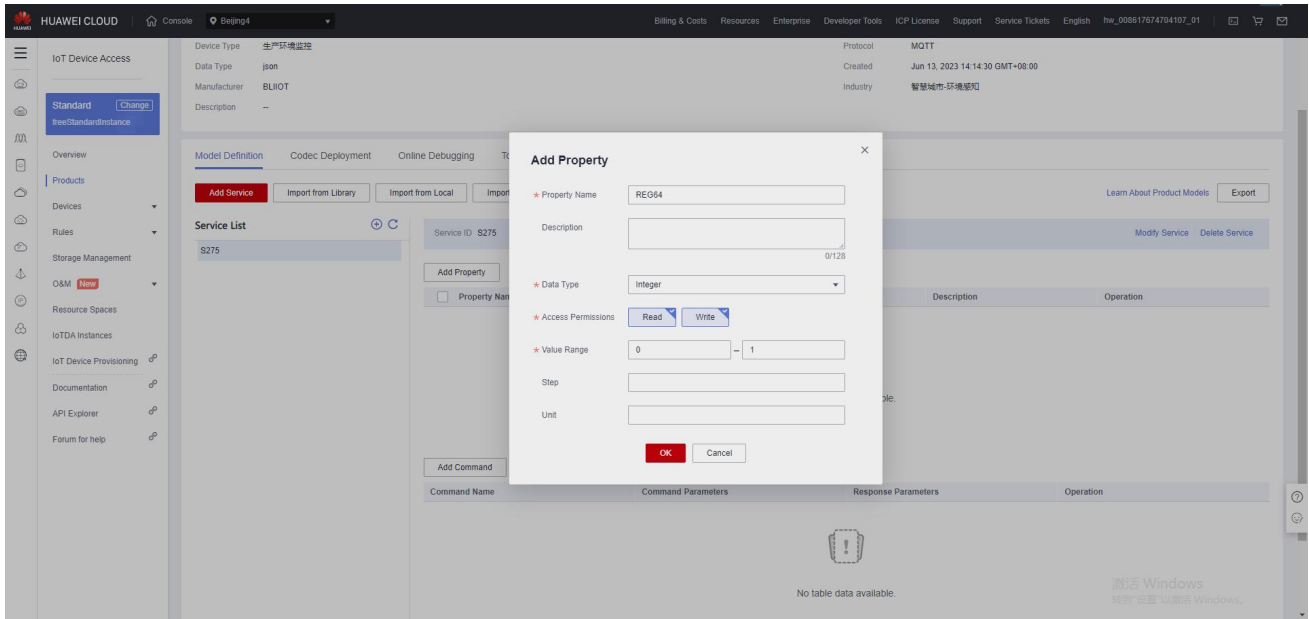

5, RTU configuration

Fill in device ID, secret key, service ID, then click write to save the parameters.

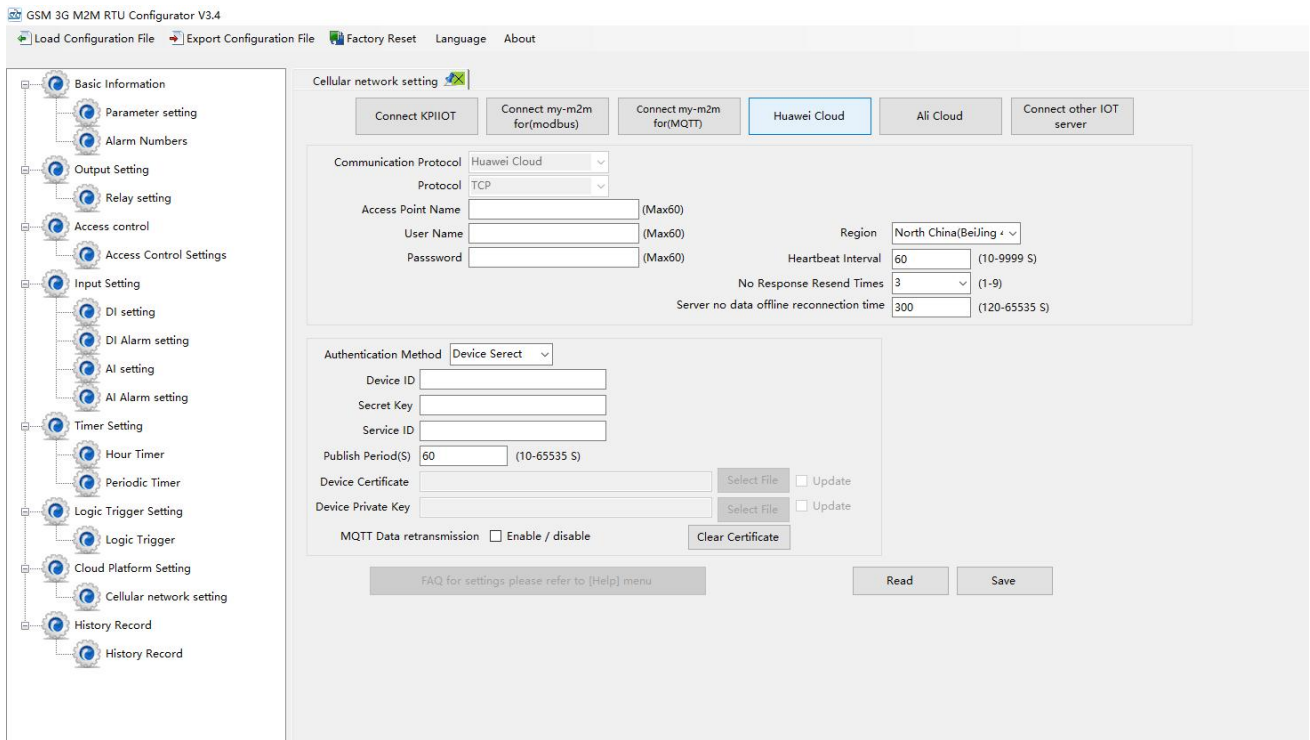

6, Check the status of the device

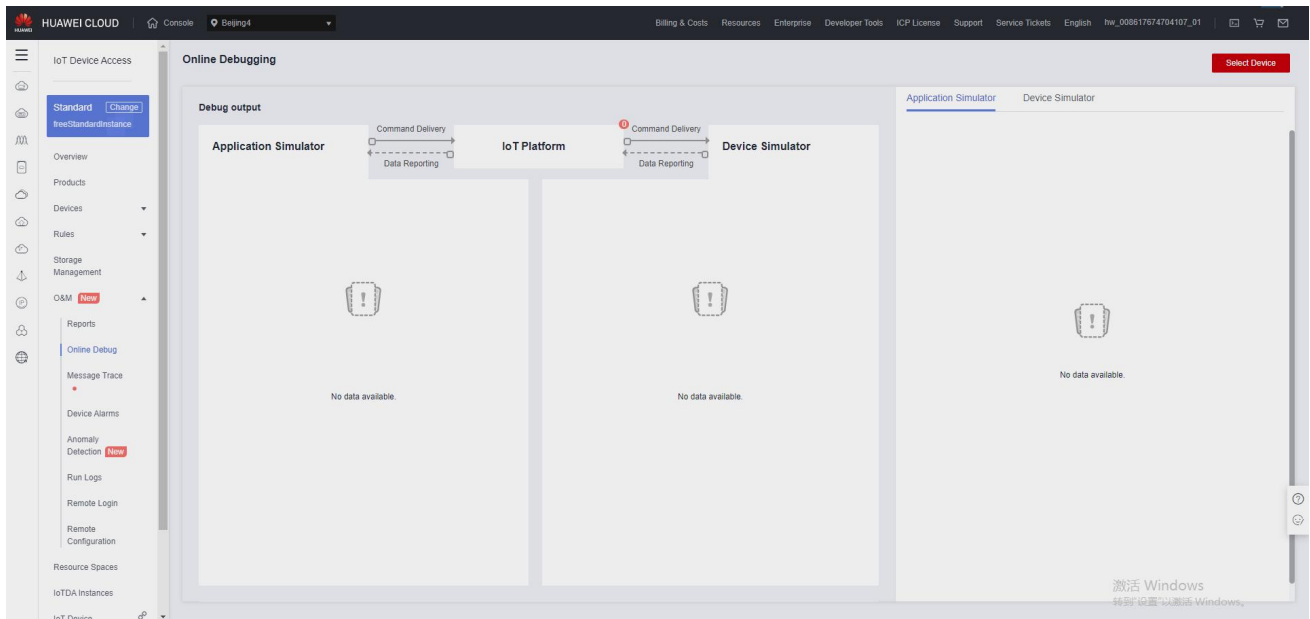

7.4 Ali Cloud

Firstly, create a product on ALI CLOUD to obtain the device certificate.

1, Create Product

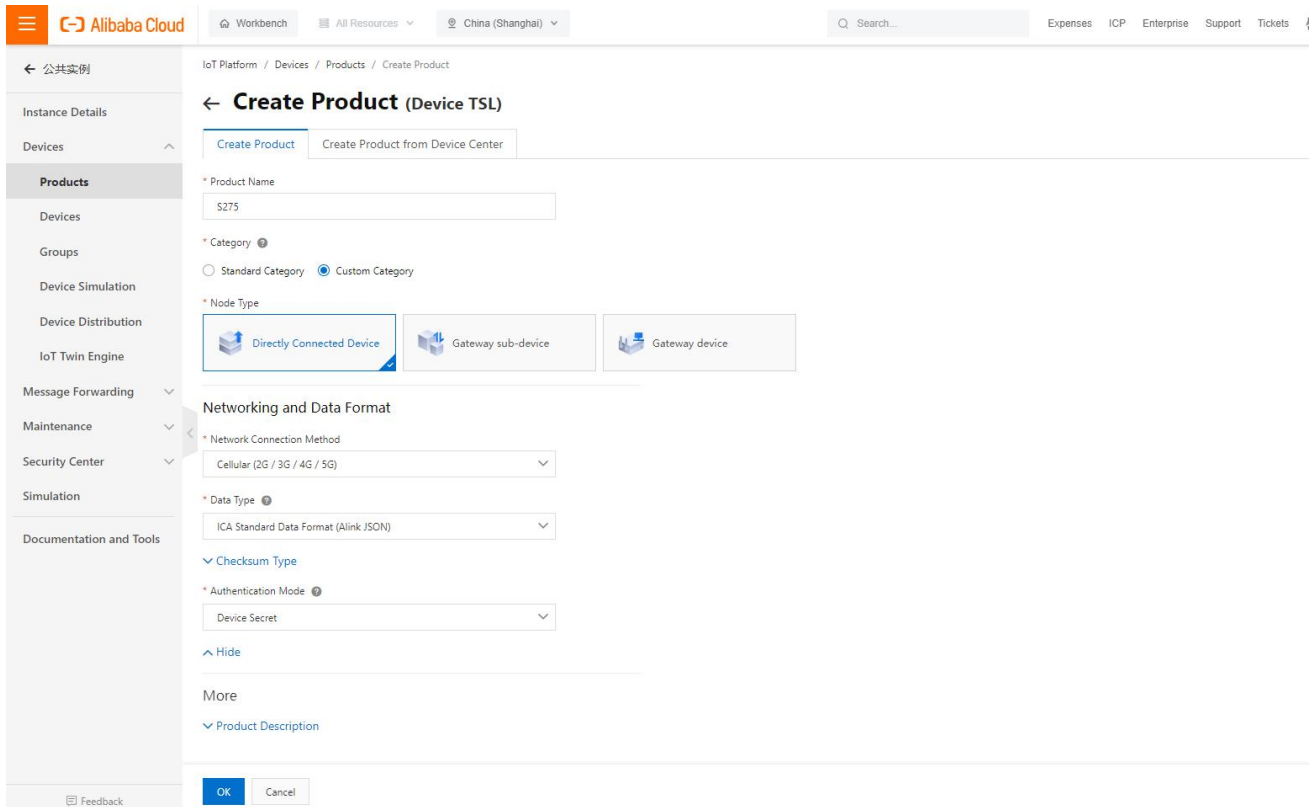

2, Add Device

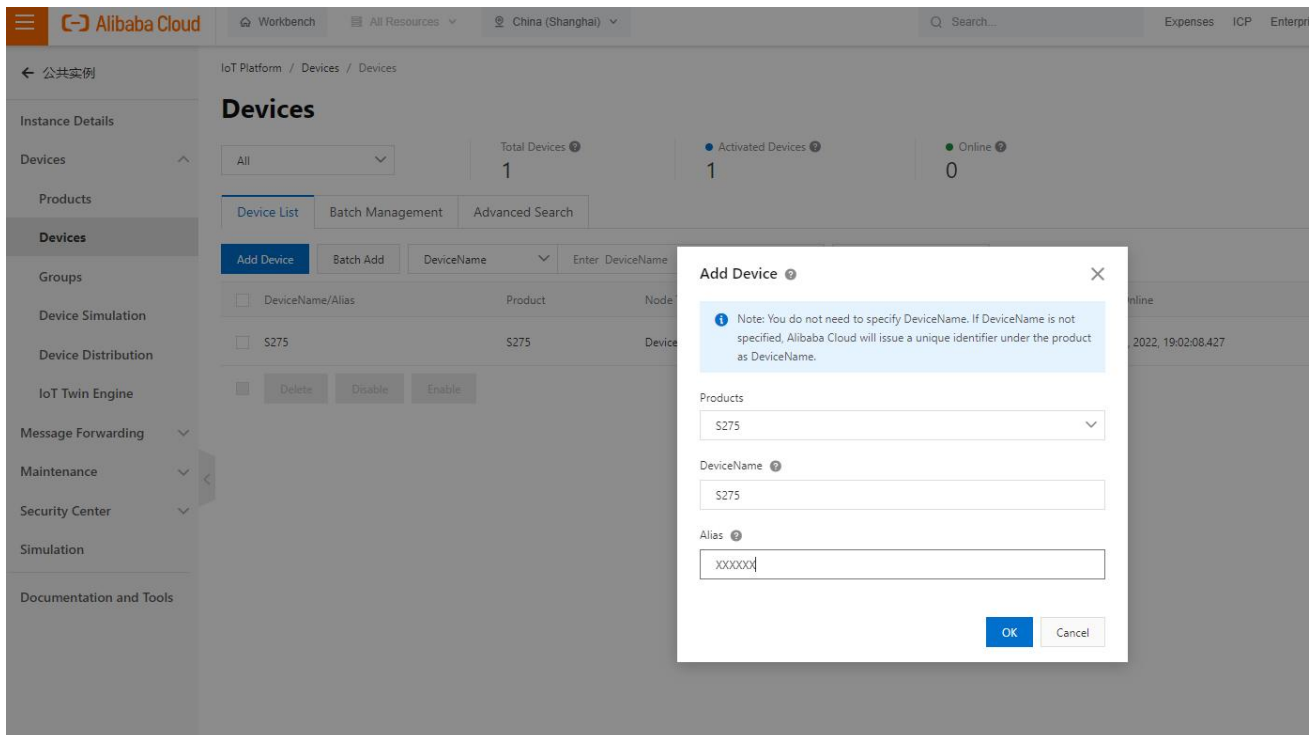

3, Obtain device certificate

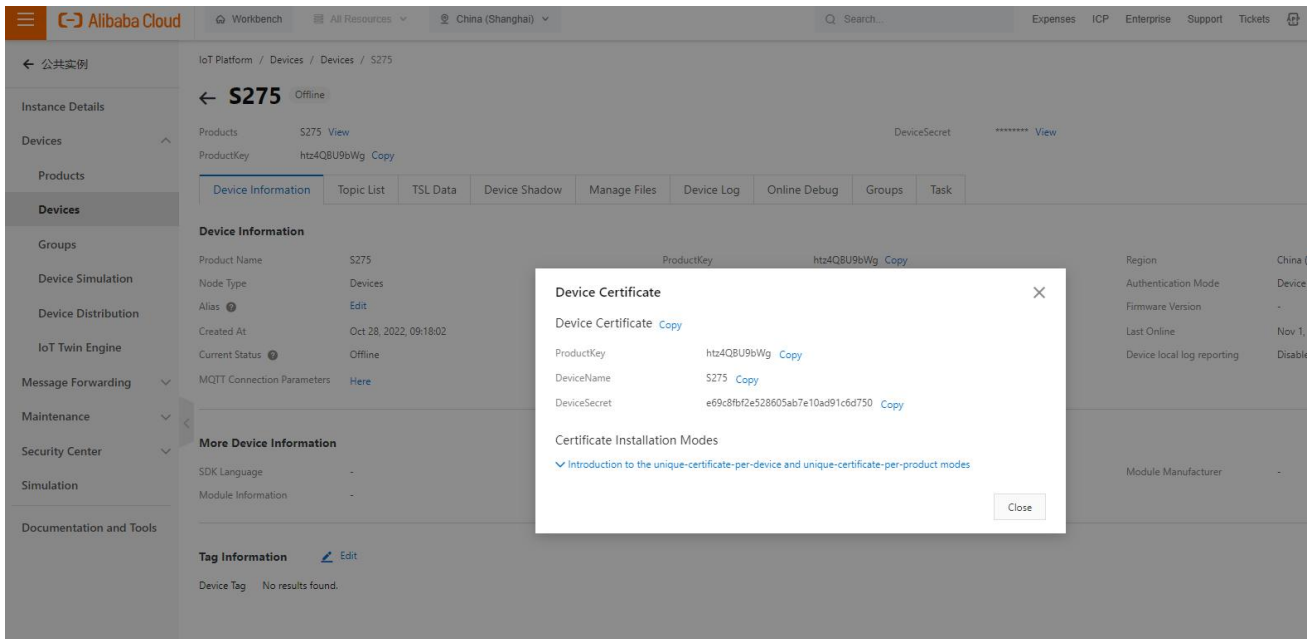

4, Add Feature

"Identifier" refer to chapter 8 Device Register Address

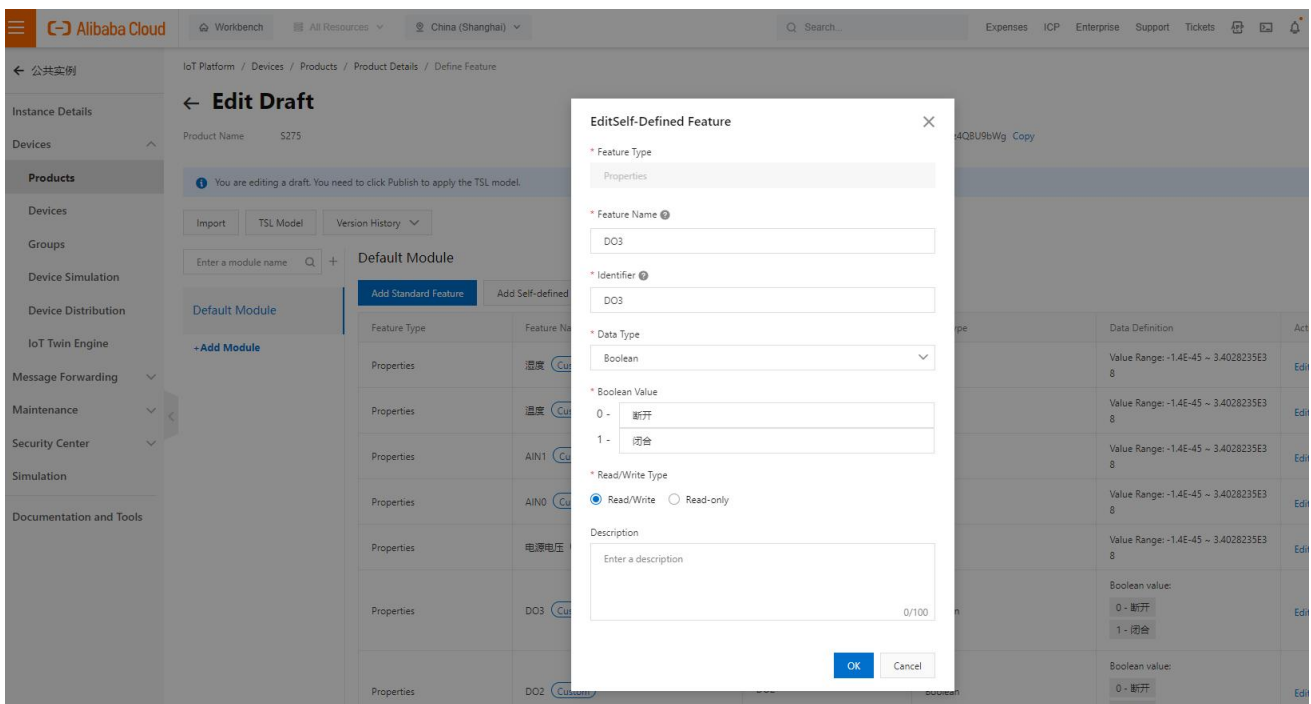

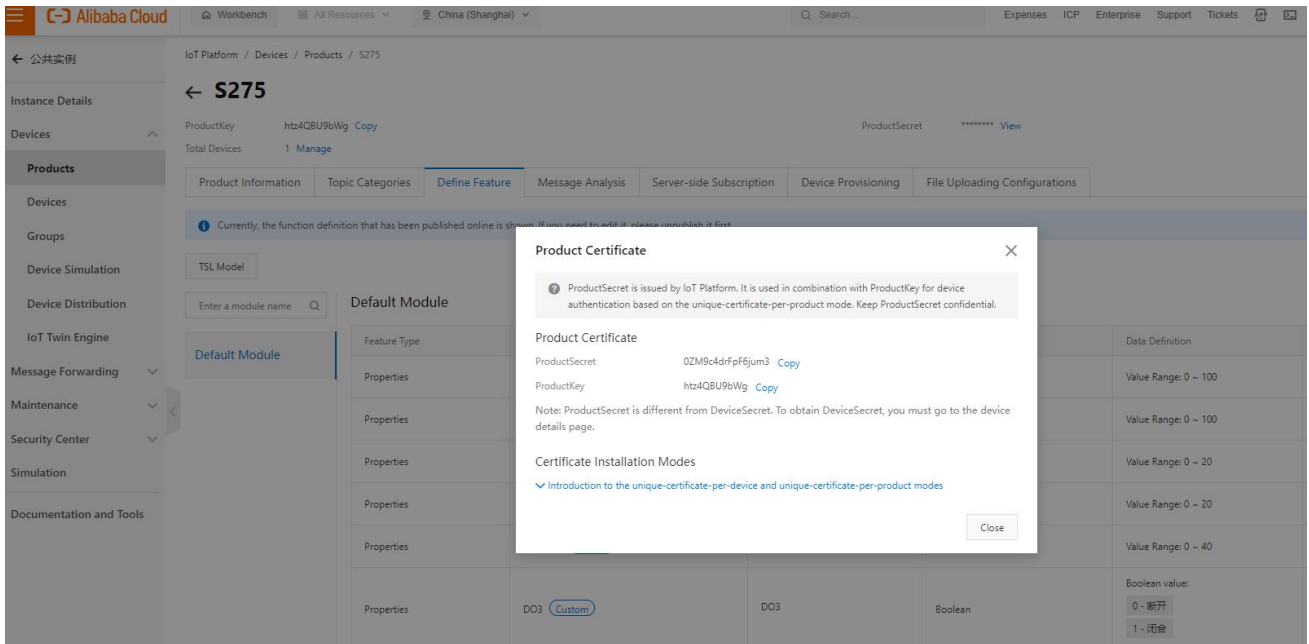

6, RTU configuration

Fill in the parameters, then click write to save the parameters.

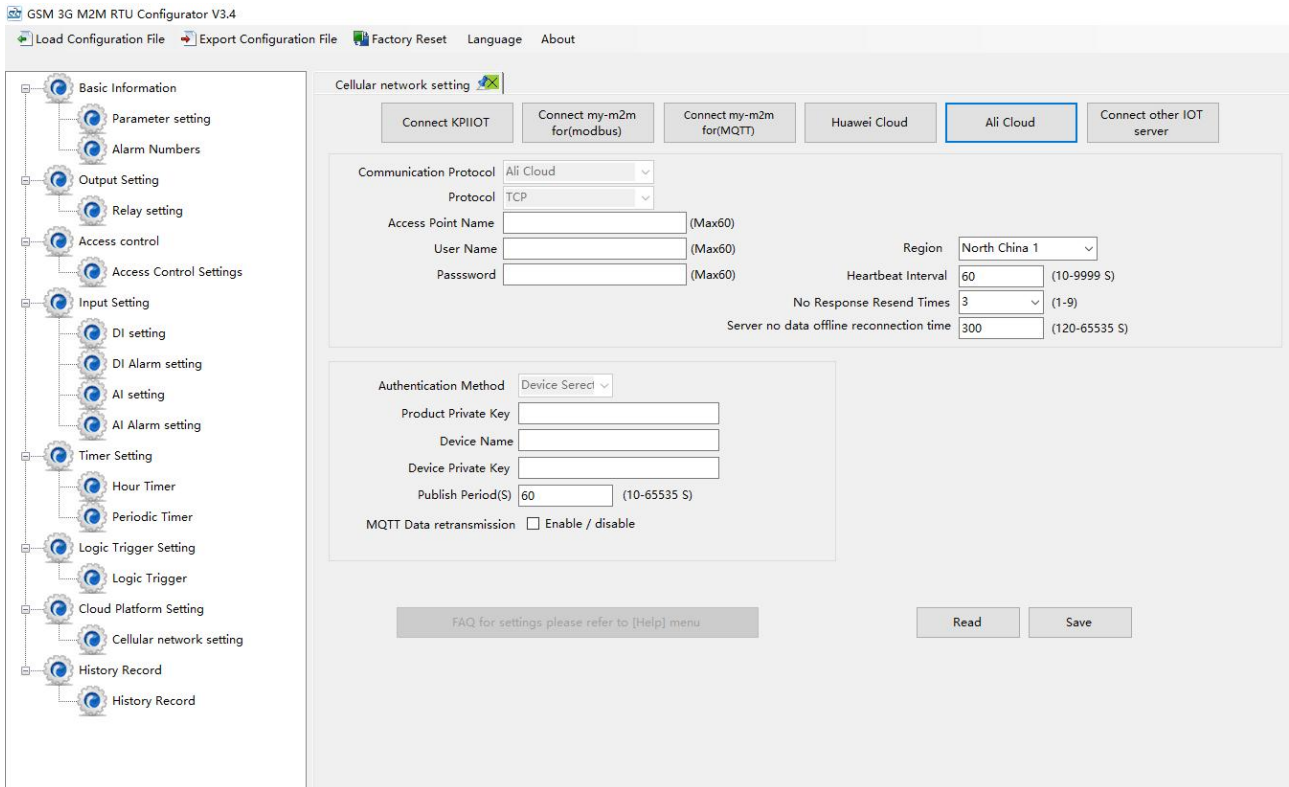

7, Check the status of the device

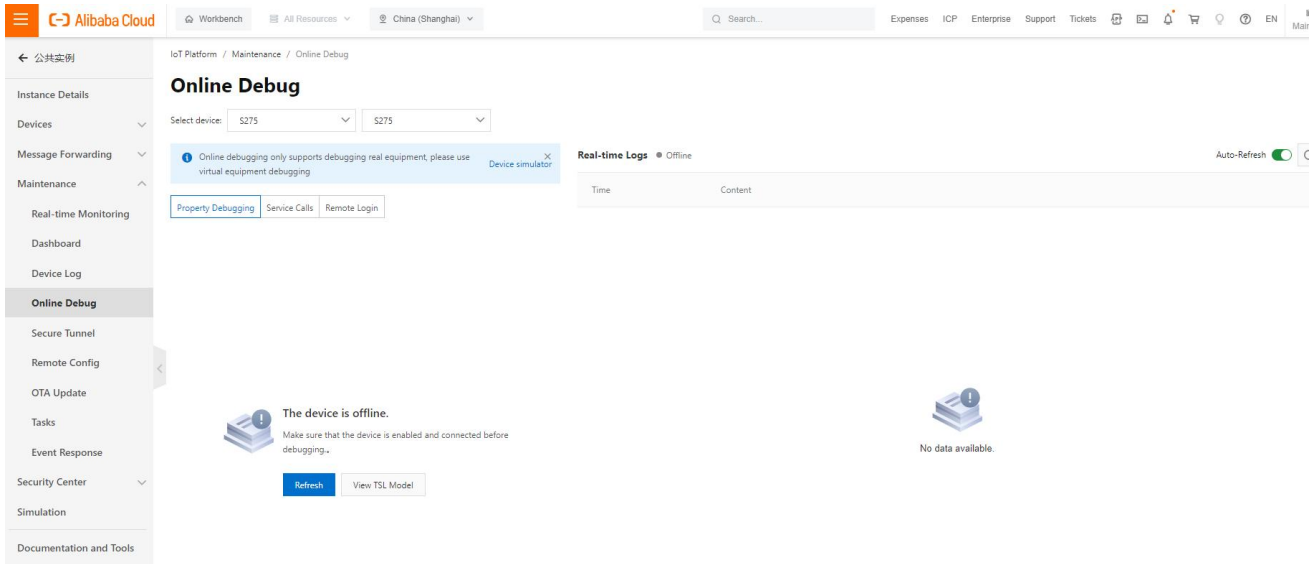

7.5 Other IoT Server

S27X supports custom cloud platform configuration, which supports MODBUS RTU, MOBUDS TCP, and MQTT protocols.

The data format of the custom MQTT protocol is the same as the data format of the MQTT of the BLIIoT Cloud V2.0 platform.

The Modbus RTU and Modbus TCP protocols are standard Modbus protocols.

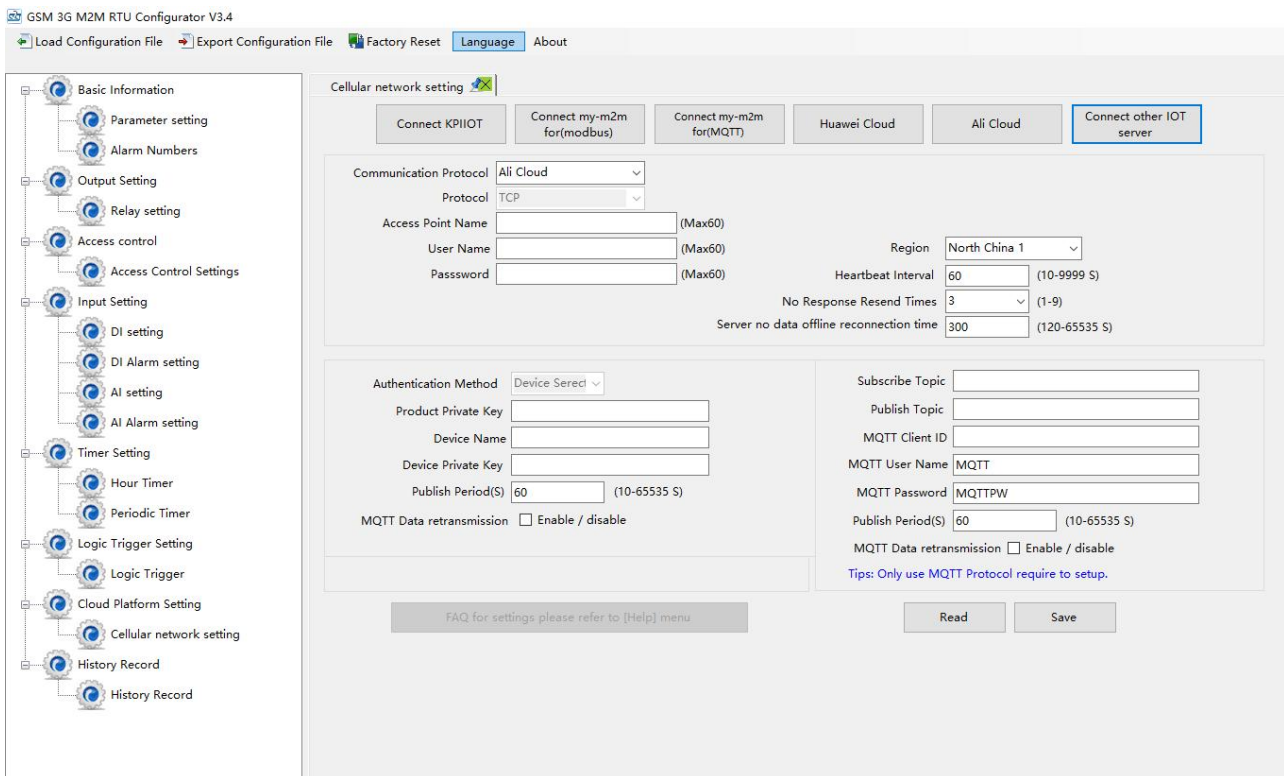

8 Device Register Address

1) Read and Write, Holding Coil (Function Code 01, Function Code 05, Function Code 15)

Register Address		Definition	Data Type	Description
Hexadecimal	Decimal			
0	0	DO0	Bool	<ul style="list-style-type: none"> ● 1: Relay close ● 0: Relay open
1	1	DO1	Bool	
2	2	DO2	Bool	
3	3	DO4	Bool	

2) Read, Input Coil (Function Code 02: Read Coil)

Register Address		Definition	Data Type	Description
Hexadecimal	Decimal			
0	0	DI0	Bool	<ul style="list-style-type: none"> ● Dry contact Short circuit: Logic 1 Open circuit: Logic 0 ● Wet contact 0-3V: Logic 0 10-30V: Logic 1
1	1	DI1	Bool	
2	2	DI2	Bool	
3	3	DI4	Bool	

3) Read, Input Register (Function Code 04: Read Input Register)

Register Address		Definition	Data Type	Description
Hexadecimal	Decimal			
0	0	AI0	32bit int	$Y=X/100$
2	2	AI1	32bit int	$Y=X/100$
4	4	AI2	32bit int	$Y=X/100$
6	6	AI3	32bit int	$Y=X/100$
8-D	8-13	Unavailable	---	---
E	14	Voltage	16bit uint	$Y=X/100$
F-17	15-23	Unavailable	---	---
18	24	Temperature	16bit int	$Y=X/100$
19	25	Humidity	16bit int	$Y=X/100$
1A	26	DI0 count value	32bit uint	Enable when DIN0 as counter mode
1C	28	DI1 count value	32bit uint	Enable when DIN1 as counter mode

1E	30	DI2 count value	32bit uint	Enable when DIN2 as counter mode
20	32	DI3 count value	32bit uint	Enable when DIN3 as counter mode

In the description, each variable is defined as follows:

Y: True value

X: The value stored in the register

"Y=X/100" means: "real value = the value stored in the current register/100"

4) Read and Write, Holding Register (Function Code 03, Function Code 06, Function Code 16)

Register Address		Definition	Data Type	Description
Hexadecimal	Decimal			
104(bit0)	260(bit0)	DI0 count clear	Bool	Write 1 to clear DI0 count
104(bit1)	260(bit1)	DI1 count clear	Bool	Write 1 to clear DI1 count
104(bit2)	260(bit2)	DI2 count clear	Bool	Write 1 to clear DI2 count
104(bit3)	260(bit3)	DI3 count clear	Bool	Write 1 to clear DI3 count

Device I/O data point read and write flag

Data Point	Flag	Type	Description
DO	DOx	Switcher	0 is open, 1 is closed
DI	DIx	Switcher	0 is open, 1 is closed
AI	AIx	Value	True value = original value
Temperature	TEMP	Value	True value = original value
Humidity	HUMI	Value	True value = original value
External power voltage	EXTPWR	Value	True value = original value
DIN0 counter	COUNT	Value	True value = original value
DIN1counter	COUNT1	Value	True value = original value
DIN2 counter	COUNT2	Value	True value = original value
DIN3counter	COUNT3	Value	True value = original value

Note:

"DOx": DO0, DO1, DO2, DO3

"DIx": DI0, DI1, DI2, DI3

"AIx": AI0, AI1, AI2, AI3

9 Upgrade

Firmware of this device can be upgraded through USB, please contact BLIIoT sales person if you need to upgrade the firmware.

10 Warranty Term

- 1) This equipment will be repaired free of charge for any material or quality problems within one year from the date of purchase.
- 2) This one-year warranty does not cover any product failure caused by man-made damage, improper operation, etc.

11 Technical Support

Shenzhen Beilai Technology Co., Ltd.

Website: <https://www.bliiot.com>