

4G Cellular IoT M2M RTU



S272 User Manual

Ver 2.51

Date Issued: 2019-09-24
King Pigeon Hi-Tech. Co., Ltd.

www.GPRS-M2M.com



Table of contents

1.	Brief Introduction -----	3
2.	Safety Directions-----	4
3.	Standard Packing List-----	4
4.	Mainly Features-----	5
5.	Physical Layout and Installation Diagram-----	6
6.	Settings & Operations -----	9
7.	Example Of Applications-----	27
8.	Device SMS Command and SMS APP-----	36
9.	Device GPRS/3G/4G Communication Protocol-----	40
10.	Upgrade Firmware-----	49
11.	Cellular Module Upgrade-----	49
12.	Warranty-----	49

This handbook has been designed as a guide to the installation and operation of S272 GSM/SMS/GPRS/3G/4G Cellular IoT M2M RTU

Statements contained in the handbook are general guidelines only and in no way are designed to supersede the instructions contained with other products.

We recommend that the advice of a registered electrician be sought before any Installation work commences.

King Pigeon Hi-Tech.Co., Ltd, its employees and distributors, accept no liability for any loss or damage including consequential damage due to reliance on any material contained in this handbook.

King Pigeon Hi-Tech.Co., Ltd, its employees and distributors, accept no liability for GSM Network upgrading or SIMCard upgrading due to the technology specifications contained in this handbook.

【UPGRADE HISTORY】

DATE	CONFIGURATOR VERSION	FIRMWARE VERSION	HARDWARE VERSION	DESCRIPTION
2018.6.21	V2.4	V2.4	V2.4	1.Modbus address and function code revised; 2.AIN/DIN alarm content setting revised; 3. Interlock event added.
2018.12.13	V2.5	V2.5	V2.4	1.DIN status revised to reverse from V2.4 version, only support V2.5 configurator software. 2.The total value range function of DIN1 pulse count upgraded.
2019.09.24	V2.51	V2.8	V2.4	1. Modify cellular default settings

Model List

Model	DIN	AIN	Relay	TH	SD Card	Extend I/O tags				Port
						Boolean	16-Bit	32-Bit	64-Bit	
S270	2	2	2	1		×	×	×	×	USB
S271	4	4	4	1		×	×	×	×	
S272	8	6	4	1	8G	×	×	×	×	USB/RS485



S273	8	6	4	1	8G	64	64	×	×
S274	8	6	4	1	8G	64	128	32	×
S275	8	6	4	1	8G	64	128	64	64
Notice	1. Default version is GSM/GPRS module inside. 2. For 3G WCDMA, 4G LTE version, please tell our sales where would you like to use them.								

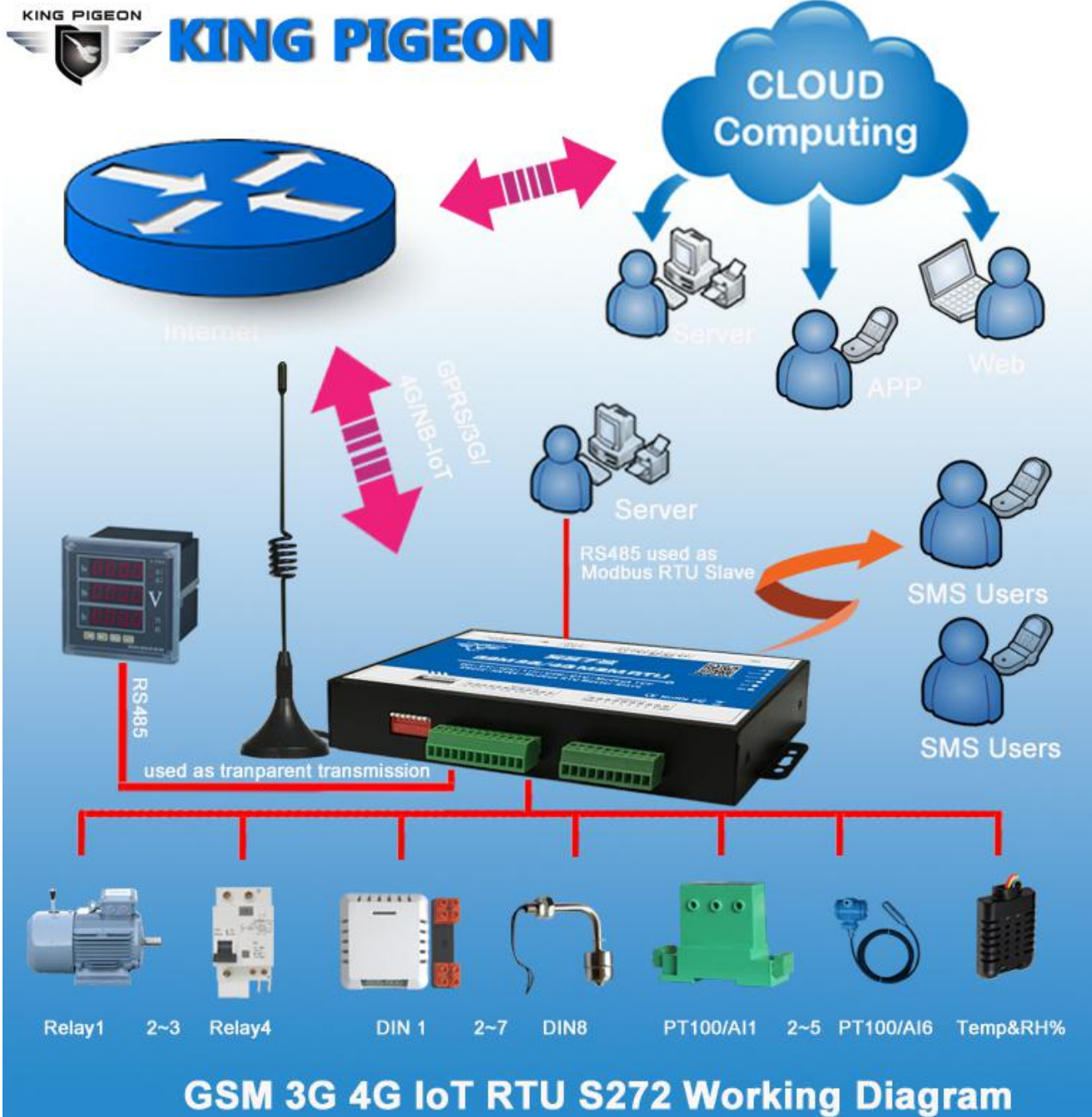

1. Brief introduction

The Cellular IoT M2M RTU is an industrial class, high reliability, high stability, and programmable Remote Terminal Unit (RTU). It embedded 32-Bit High Performance Microprocessor MCU, inbuilt industrial Cellular module. It provides 8 digital inputs, 6 analog or PT100 Resistance Temperature Detector (RTD) inputs, 4 relay outputs, 1 ambient sensor input for monitoring onsite temperature and humidity, and RS485 serial port. It can monitoring and operates the I/O ports by SMS, APP, Web Server, internet, timers and programmed inter-lock events automatically.

The Cellular IoT M2M RTU inbuilt TCP/IP protocol stack make it suitable for internet of things (IoT) applications, it can be easily to operate by the provided cloud, app, and web server, or integrated to you IoT applications according to the TCP/UDP protocol, or integrated to SCADA systems by standard Modbus TCP protocol, too. This is very useful if you need remote control onsite devices with low cost solution.

The Cellular IoT M2M RTU is design for working in the harsh industrial application environment, widely used in a variety of industrial automation, security monitoring system, automatically measurement and control system, BTS monitoring, remote data acquisition, telemetrically systems, automatically control system. It can be used as a remote switch, remote I/O, remote smart PLC, timer switches.

The Cellular IoT M2M RTU can be used as remote access control for BTS monitoring, the authorized users can open the gate or turn on the machine with a free charge call at specified time, this is useful for daily maintenance to save the time of traditional authorized.

The Cellular IoT M2M RTU supports transparent data transmission and performs as Modbus Slave over GPRS/3G/4G network and RS485 serial port.

Typically applications:

BTS Monitoring, Security Alarm System applications, Supervision and monitoring alarm systems, Automatic monitoring system, Vending Machines security protection, Pumping Stations, Tanks, Oil or Water levels, Buildings and Real Estate, Weather Stations, River Monitoring and Flood Control, Oil and gas pipelines, Corrosion protection, Temperatures, water leakage applications, Wellheads, boat, vehicle, Energy saving, street lights control system, Valve controls, Transformer stations, Unmanned machine rooms, Control room application, Automation System, M2M, Access Control System, etc.

2.Safety Directions



Safe Startup

Do not use the unit when using GSM/3G/4G equipment is prohibited or might bring disturbance or danger.



Interference

All wireless equipment might interfere network signals of the unit and influence its performance.

3. Standard Packing List

Gateway X1; AC/DC Adaptor X1; GSM/3G/4G Antenna X1;User Manual X1; PC Configurator X1 .

Note: The package does not include any SIM card.

Optional: 35mm Standard DIN rail fixed Bracket

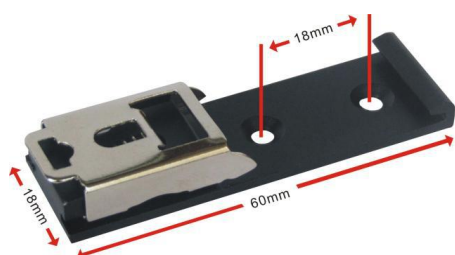

35mm DIN Rail Fixed Bracket



4. 1 Mainly Features

- GSM/GPRS/3G/4G network communication, can be operated from anywhere, no distance limitation;
- Wide range power supply 9~36VDC with over voltage and phase-reversal protection;
- Embedded ARM [®] Cortex [™] -M4 32 Bit RISC Core, 168 MHz inside, RTOS system, reliable performance with in-built watchdog;
- 8 digital inputs, compatibles dry and wet contact. Logic level: 0~0.5V or short circuit treated as close, +3~30V or open circuits treated as open. First one input can be used as counter, sampling frequency is 1Mhz, second can be used as Arm/Disarm;
- 4 relay output (5A/30VDC,5A/250VAC), can auto control by timer, alarm-link and remote control by SMS, cloud. The first DO can set time to control by authorize number;
- 1 temperature & humidity sensor input for monitoring onsite environment, the sensor model is AM2301, Measures temperatures from -40-80°C,0.5°C accuracy, Relative Humidity from 0-99RH%, accuracy is 3%;
- 6 analog inputs, 12bits resolution, supports 0-5V, 0-20mA, 4-20mA output transducers;
- Inbuilt 8G SD card to save up to tens of thousands historical data and events;
- 1 RS485 port, support Modbus slave protocol, can link up to SCADA、HMI、DSC., also support data transparent transmission;
- Powerful SMS function: Threshold high SMS alert, SMS set, SMS inquiry, SMS command for Modbus PLC...;
- Inbuilt 2 DC output for external transducers to save wiring cost;
- Automatically resend the data while communication interrupt or failure, and failure will alert by SMS text to users;
- Supports remotely restart the RTU, and configure& operate it by SMS commands remotely;
- 10 SMS Alert and auto dial numbers for receiving alarm message, can program to receive specified alarm message. The authorized numbers also can dial to open the door or turn on/off machine with a free charge call at the specified time;
- Inbuilt inter-lock logic programmer and powerful timer program function;
- Modular structure design, replace a module can upgrade the network from 2G to 3G/4G or 3G to 4G;
- Support SMS, dial, GPRS, 3G , 4G network for alert, USB port for configuration and upgrade firmware;
- Inbuilt large capacity automatically rechargeable backup battery, alert when external power failure;
- Support TCP/UDP, Modbus TCP, Modbus RTU over TCP, King Pigeon IoT RTU protocol and data transparent transmission function;
- Using metal shell, protection class IP30. Metal shell and system security isolation, especially suitable for industrial applications in the field;
- L195 * W88 * H30mm, compatible wall installation and DIN35mm industrial rail installation.

4. 2 Specifications

Item	Reference Scope
DC Power supply	Standard adapter: DC 12V/2A Range 9-36VDC
Power consumption	Standby:12V/50mA; Working Max.: 12V/150mA
GSM Frequency	850/900/1800/1900Mhz
3G/4G	Optional: WCDMA/TDD-LTE/FDD-LTE
TCP/IP stack	TCP,UDP
SIM interface	Supporting 3V and 1.8V SIM Card
External antenna	SMA Antenna interface, 50 Ohm, Gain: 3dB
Serial Interfaces	1 USB Port
Protocols	SMS, GPRS UDP,TCP, Modbus RTU over TCP and King Pigeon RTU protocol.
RS485	1 RS485, Support Transparent transmission and Modbus RTU Slave
Digital Inputs	8 Digital input, NC/NO type, one of it can be used as Pulse Counters;
Analog Inputs	6 Analog Inputs. 12 bit resolution, 0-5V or 0-20mA or 4-20mA;
Temp.&Hum Inputs	Temperature range: -40°C to +80°C, Humidity Range: 0~100%RH;
Relay Outputs	4, Rated: 5A/30VDC,5A/250VAC
Power Outputs	2 Port, for external device;
Memory Capacity	Internal 8G SD card inside, can save the data for 100000events.
Backup Battery	3.7V 900mAH
Temperature range	-20-+70 °C
Humidity range	Relative humidity 95% (condensation free)
Exterior dimension	195mm*88mm*30mm
Net Weight	350g

5. Physical Layout and Installation Diagram

5.1 Control Unit size and physical layout

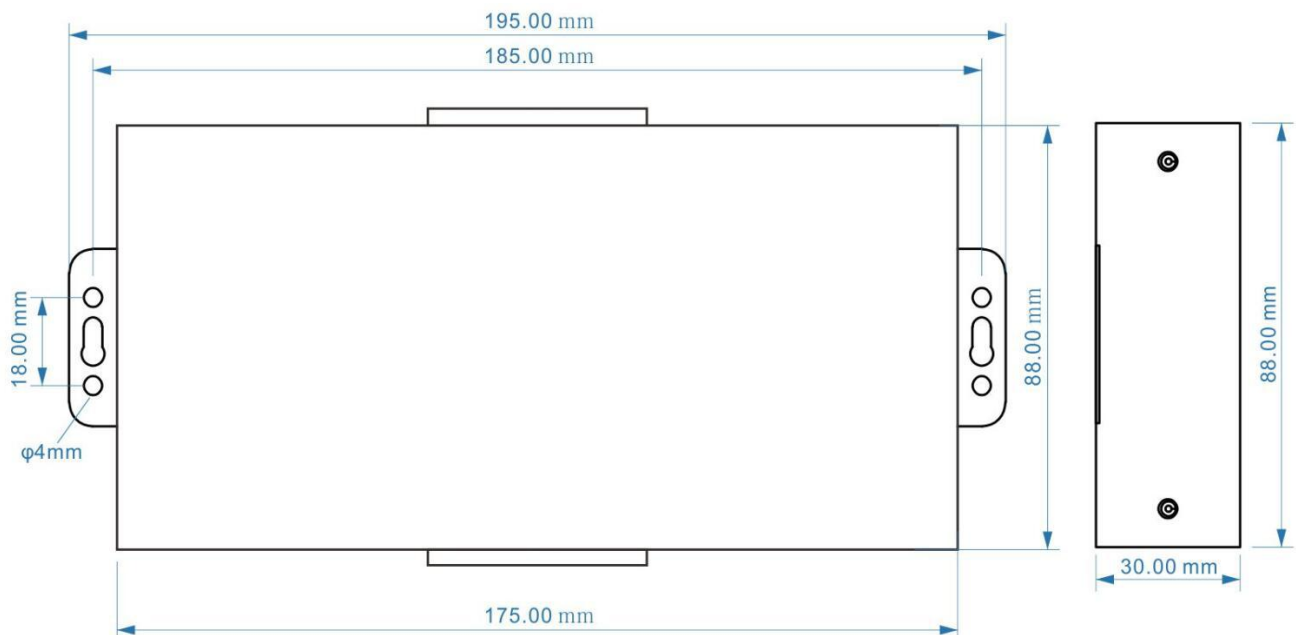



S272

GSM 3G/4G M2M RTU

8DI / 6AI / 4DO / 1TH / USB / DTU / Modbus TCP
RS232 / RS485 / Modbus RTU Master-Slave

Scan to download the APP

- Power
- Alarm
- Run
- Arm
- 485

Mode	Analog Input Type
0	1 2 3 4 5
Set	V V V V V
Run	mA mA mA mA mA

Analog Input											
0+	0-	1+	1-	2+	2-	3+	3-	4+	4-	5+	5-

Digital Input									
GND	0	1	2	3	4	5	6	7	GND

LED Indicator Definition

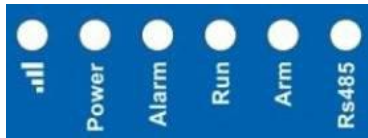



Power	RTU status indicator, LED ON when switched RTU on..
	Cellular network indicator. When 2G register network, off 2 seconds, on 0.5s and so on; When 3G 4G register network, on 2s, off 0.5s...Flicks quickly means data transmission.
Alarm	Alarm Indicator, alarm will ON and flick. Normally is OFF;
Arm	Arm/Disarmed Indicator, Arm is ON, disarmed is OFF.
Run	RTU running status indicator, ON or OFF stands for RTU halted, flicks slowly stands for RTU running.
RS485	When transmitting data by RS485, the LED will flick, otherwise, it is off.

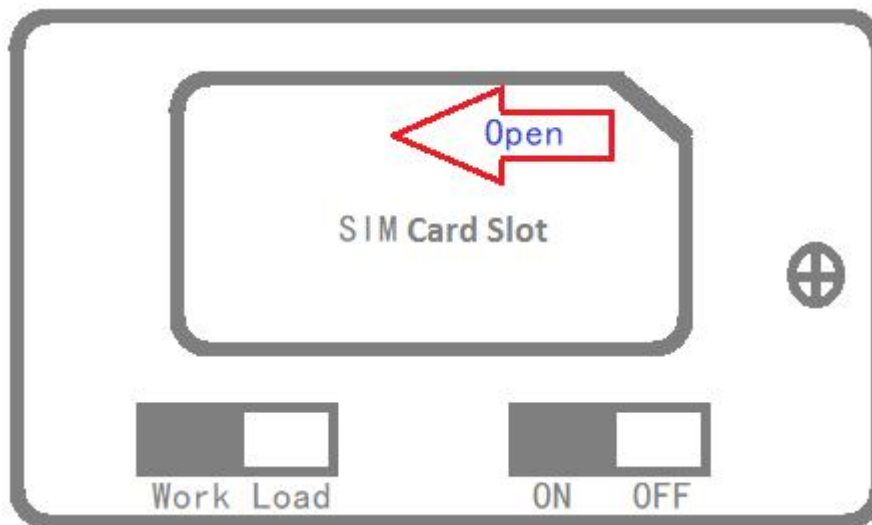

Backside Switch & Button Definition

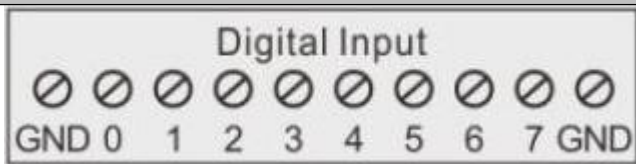

SIM Card Slot	For SIM Card Installation, only supports 1.8V/3V SIM Card
Power Switch	For switch ON or OFF the RTU
Upgrade	For upgrade firmware purpose only. Only when upgrade new firmware version will use it,

Firmware Switch	otherwise keep it at Work Side all the time.																												
Power Connector Definition																													
																													
DC IN+	External DC Power input port, Connect to 1.5A@9~36V DC power, positive electrode.																												
DC IN-	External DC Power Input port, contact to negative electrode																												
DC Out+	Power source output port, positive electrode. Provides power from RTU to external transducers or sensors or detectors. The output current should less than the power from DC IN inputs. If adapter current is 2A, then suggest external transducer current to be less than 1.5A																												
DC Out -	Power source output port, Negative electrode.																												
DIP Switch Definition																													
<table border="1"> <tr> <td>Mode</td> <td colspan="6">Analog Input Type</td> </tr> <tr> <td></td> <td>0</td> <td>1</td> <td>2</td> <td>3</td> <td>4</td> <td>5</td> </tr> <tr> <td>Set</td> <td>V</td> <td>V</td> <td>V</td> <td>V</td> <td>V</td> <td>V</td> </tr> <tr> <td>Run</td> <td>mA</td> <td>mA</td> <td>mA</td> <td>mA</td> <td>mA</td> <td>mA</td> </tr> </table>		Mode	Analog Input Type							0	1	2	3	4	5	Set	V	V	V	V	V	V	Run	mA	mA	mA	mA	mA	mA
Mode	Analog Input Type																												
	0	1	2	3	4	5																							
Set	V	V	V	V	V	V																							
Run	mA	mA	mA	mA	mA	mA																							
SET/RUN	For setting the RTU Mode is in Configuration Mode or Run mode. Switch it to upside is Set Mode, under this mode, the user can use PC Configurator via USB cable to configure the RTU Parameters or Read Parameter settings. Switch it to Downside is Run Mode, under this mode, the RTU is in Running mode. Tips: <i>When device mode changed, need to switch off/on the device.</i>																												
0/V/mA	The 1 st channel of analog input type switch. If not use this channel then no matter is upside or downside. Switch it to upside stands for the 1 st analog input should connect to 0~5V voltage output transducer. Switch it to Downside stands for the 1 st analog input should connect to 0~20mA or 4~20mA current output transducer. Tips: <i>The wrong side will cause device can't read the analog value.</i>																												
1/V/mA~5/V/mA	The 2 nd to 6 th channel of analog input type switch. If not use this channel then no matter is upside or downside. Switch it to upside stands for the related analog input should connect to 0~5V voltage output transducer. Switch it to Downside stands for the related analog input should connect to 0~20mA or 4~20mA current output transducer.																												
Analog Input Definition																													
																													
<i>Analog inputs, Sampling frequency 200mS, 12bits resolution, supports 0-5V, 0-20mA, 4-20mA output transducers, please refer to abovementioned DIP Switch Definition to connect the correct transducers.</i>																													
0+/0-	The 1st Channel Analog input. + stands for positive electrode, - stands for negative electrode.																												
1+/1- ~5+/5-	The 2 nd ~6 th Channel Analog input. + stands for positive electrode, - stands for negative electrode.																												
Digital Input Definition																													
																													

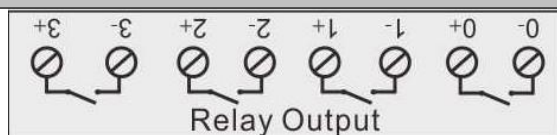
Dry contact or wet contact, sampling frequency 200mS. Logic level: 0~0.5V or short circuit treated as close, +3~30V or open circuits treated as open. One of the input can be used as counter, sampling frequency is 1Mhz, the second input can be used for Arm/Disarm.

0	The 1st digital input, positive electrode.
1~7	The 2 nd ~8 th digital input, positive electrode.
GND	GND for digital inputs, negative electrode.
ATN Port Connector Definition	
ATN	GSM/3G/4G Antenna connector, 50Ohm, SMA male.
USB Port Connector Definition	
USB	USB port, for configuration and upgrading firmware and exporting historical data;
Temperature Humidity Sensor Port Definitions	
	
T/H	Temperature & Humidity sensor AM230x input. Measurement Range: Temperature: -40°C to +80°C, Humidity: 0~100%RH.
Digital Solid Relay Output Connector Definition	
	
Solid Relay inside for outputs, Rated Capacity: 5A/30VDC, 5A/250VAC.	
0+/0-	The 1st Channel Solid Relay Output. + stands for positive electrode, - stands for negative electrode.
1+/1- ~ 3+/3-	The 2 nd ~ 4 th Channel Solid Relay Output. + stands for positive electrode, - stands for negative electrode.
RS232/RS485 Ports Definition	
	
GND	Ground
A/B	RS485 A /B

6. Settings & Operation

The GSM SMS GPRS 3G 4G Cellular IoT M2M RTU is user-friendly design. The user can setup it or export historic data by the PC Configuration through USB cable, and upgrade firmware by USB port. The GSM SMS GPRS 3G 4G Cellular IoT M2M RTU also can be configured some basically parameters by SMS Commands, please refer to SMS Command App or **Command List**.

Tips!

- 1) Please insert the SIM Card firstly, and install the GSM/3G/4G Antenna, please power on to check the LEDs status according to above mentioned LED Definitions, keep switch on it during the programming.
 - 2) The PC Configuration in the CD, please click it to run it. Also can download from www.GPRS-M2M.com under S272 page directly.
- Below is the steps to setup the parameters by PC Configuration, please follow it step by step.



Start to Configure:

Step1: Install the Configurator

The Configurator in the CD or download from www.GPRS-M2M.com, then installs it on the computer.



Step2: Connection

Please insert the SIM Card, and install the GSM/3G/4G Antenna.

Step3: Switch the DIP Switch to Setup Mode. (Before Power On the RTU)

Switch it to upside is Set Mode, under this mode, the user can use PC Configurator via USB cable to configure the RTU Parameters or Read Parameter settings.

Notice:

Please switch it to Downside after you finished the configurations. Otherwise, the RTU cannot work properly. The Downside is Run Mode, under this mode; the RTU is in Running mode.

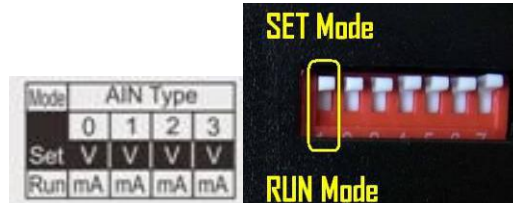

Step4: Connect the Gateway to the PC by USB Cable. And connect the external DC Power to DC Power Ports, Power on, and switch on the device, see below:

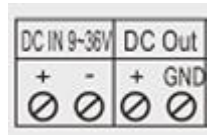

Step5: Install USB Driver

Install the USB Driver to the computer from the CD firstly. When successful, it can be found out at the device manager of the XP or Windows 7 or Win8/Win10, please see the below photo. Also, the driver for different OS can be downloaded from Silicon Laboratories, Inc. <http://www.silabs.com>, the model is CP210x.

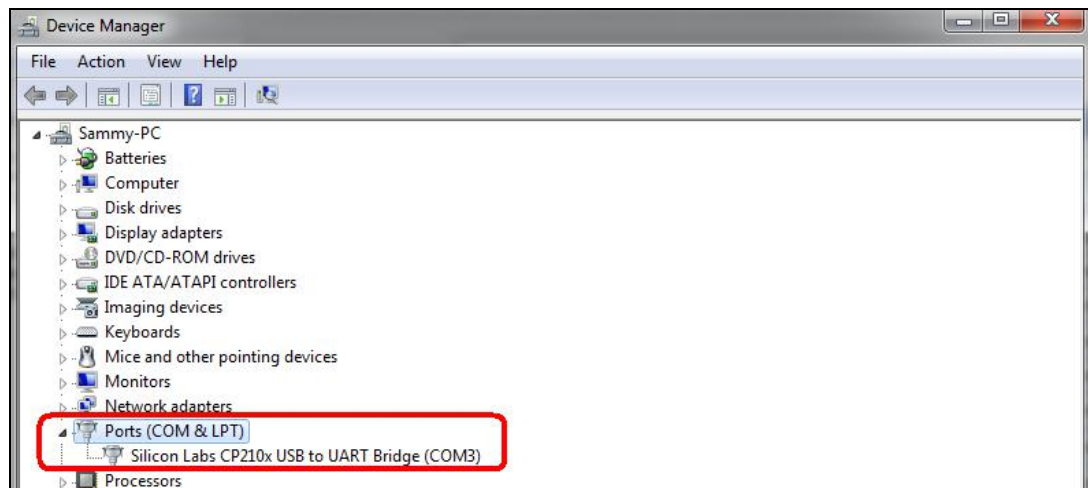

Step6: Run the Configurator (Compatible with Windows XP/7/8/10)

Tips: In some computer, it required download net framework 4.0 while installation, then please click "Yes" to go to Microsoft website to download this service pack.



Please click to run it. Enter the password, default is 1234. Then you can enter the configuration page as below:

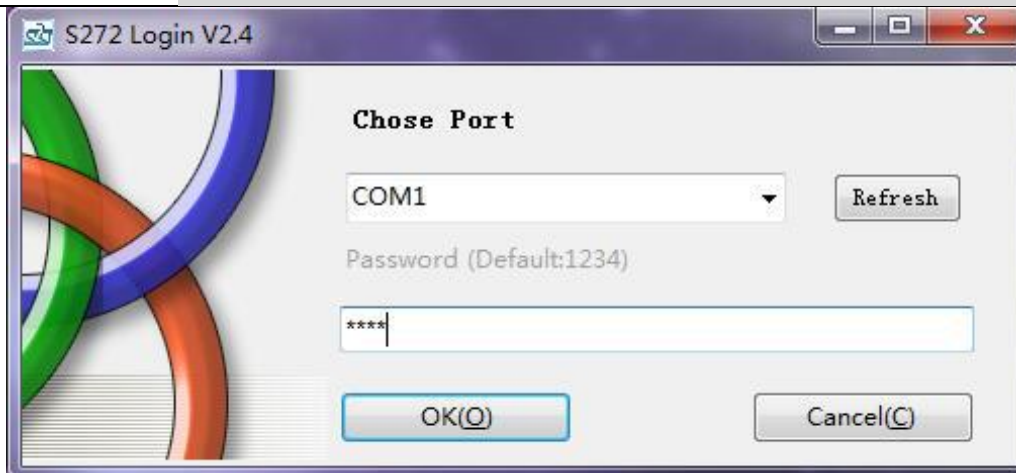

Notice:

If display the below windows, then means the RTU connect to the PC failure. The reasons are below:

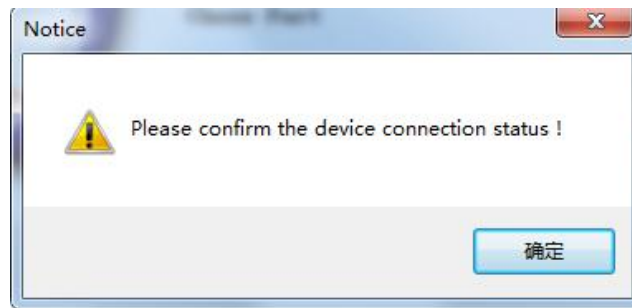

- 1) USB Driver installation failure;
- 2) USB Cable connection is disconnected;
- 3) The DIP Switch in RUN mode, not in SET mode;
- 4) The Upgrade Firmware Switch at Load side, not at Work side.
- 5) Power Switch switched off or DC Power Connection is disconnected.

Step7: Choose the correct "COM port" in device manager above, enter the password(default is 1234),click the "OK" to connect and start to program

Details please check the picture as below:

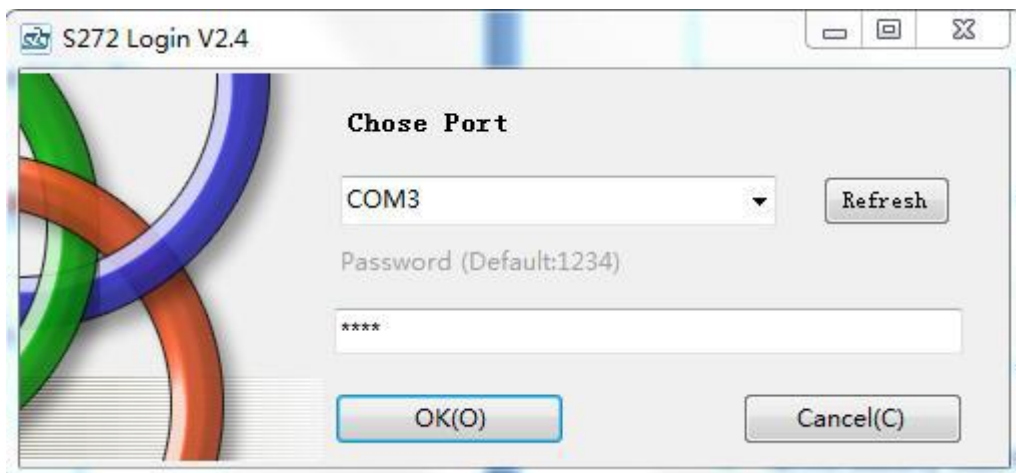

Tips: If not connect successfully, will not enter into next step. Pls check if USB connect well, or COM port and password correct or not.

 **Setting Self-checking**

Phenomenon	Possible Reason
Can't enter software	<ol style="list-style-type: none"> 1. USB Driver installation failure; 2. COM Port not correct or USB driver installation failure; 3. Device not enter into setting mode: <ol style="list-style-type: none"> 1) Only power light on, that means the Upgrade Firmware Switch at Load side, not at Work side. Solution: Switch the power switch to OFF----> Upgrade switch to Work side----> Power switch to ON. 2) Signal light flicks, that means device in working mode. Maybe had not rebooted the device after switch mode switch to Set. (In setting mode, Power light normal ON, Run light flicks, other lights Off.)
After switching panel on, only Power light on, panel can't work	<ol style="list-style-type: none"> 1. The Upgrade Firmware Switch at Load side, not at Work side. Solution: Switch the power switch to OFF---->Upgrade switch to Work side----> Power switch to ON; 2. SD card fall out from the slot. Solution: Shake panel to listen if there is voice or not; 3. In upgrade mode, use upgrade tool erased the firmware.
Can't enter into working mode	<ol style="list-style-type: none"> 1. The Upgrade Firmware Switch at Load side, not at Work side. Solution: Switch the power switch to OFF---->Upgrade switch to Work side----> Power switch to ON; 2. Device in setting mode. Solution: Switch device OFF---->Mode switch to "Run"---->Switch the device on.
Can't find COM Port	<ol style="list-style-type: none"> 1. Have not installed driver; 2. PC system problem cause driver installation failure, can't support Apple OS system. 3. Check USB line, and try other common driver software such as "Drive TheLife".
In working mode, the device not response the Modbus command	Have not set the device ID. Solution: In setting mode, set device ID---->Switch the device to Run mode.
After switching panel on, not running according to parameter setting	After parameter setting, although clicked "Save" in every page, but missed the final "Save Setting" in the menu. Solution: Back to Set mode---->Click "Save" Button after setting one page---->After all page set successfully, click "Save Setting" in the menu.

 **Terms usually used by Cellular IoT M2M RTU**

Cellular IoT RTU, Modbus RTU, Modbus Slave, Modbus RTU Over TCP, Modbus TCP, Arm, Disarm...

 **Configurator software interface and running**

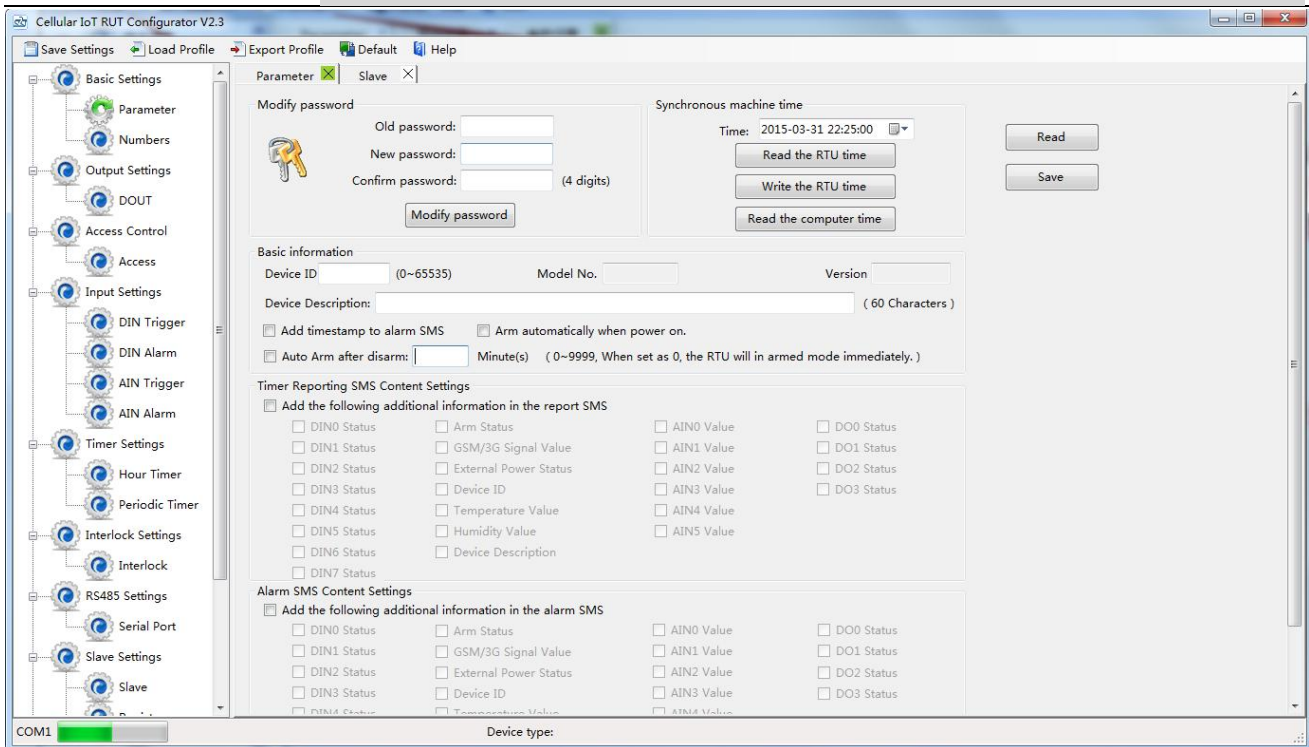

Save Settings: Click it to save all of the PC Configurator parameters to the RTU;

Load Profile: Click it to load additional Profile to the PC Configurator;

Export Profile: Click it to save the present configuration parameters as a profile for next RTU configuring or backup the parameter settings.

Tips: The Load Profile and Export Profile is very useful while you need to program bulks of RTU with similar parameters. After programmed the first unit then you can export profile to save it, for the second RTU then you can load profile directly to save you time.

Default: Click it to recovery the parameters to factory defaults.

Notice:

1. After setting or revising parameter, need to click the "Save" button of this page, then click "Save Settings" in menu for saving parameters in device
2. Before S272 export profile, need to read Slaves configuration details first, to avoid Slaves information missing.
3. Easy way to revise parameter: Open parameter setting page---->Click "Read" button to get device current value ---->Revise and click "Save" button---->Click the "Save Settings" button in the menu.
4. Switch the device mode to "Run" as below, otherwise it will not work;



5. Reboot the device, switch the Power Switch to OFF, then switch it to ON, the device will enter into normal running mode after that

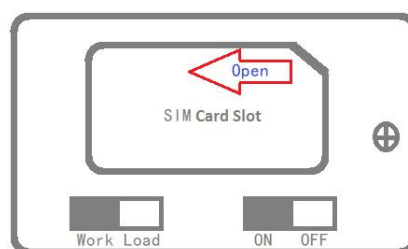



Basic Settings

Reminder: Please click the "Read" for previous parameter before starting to set.

Modify Password: This is for modifying the RTU's Password, default is 1234.

Synchronous device time: This is to setup the RTU's time for daily report or other timers. After click **Write the RTU Time**, the RTU will be synchronous the same time as the PC. If connect to King Pigeon Cloud Server, no need this step.

Device ID: Non-necessary. This is mainly for monitoring center to identify the RTU; If communicate via Modbus protocol, device ID only can be 1~247.

Device description: This is the description of the RTU, e.g.: installation address, usage instructions and so on.

Add Timestamp to Alarm SMS: Tick it stands for while alarm occurrence, the Alarm SMS will include the RTU'S current time information at the SMS Content.

Arm automatically when Power On: Tick it stands for once the RTU powered up, the RTU will enter into Arm Mode automatically.

Auto Arm after Disarmed: Fill the timeout to enter into Armed Mode automatically after disarmed operation. This is useful for security protection applications.

Tips:

Arm: Under this mode, any alarm occurrence will send SMS and dial the authorized numbers immediately. And execute the programmed I/O outputs.

Disarmed: Under this mode, alarm occurrence will not send SMS & dial the authorized numbers.

Timer Reporting SMS Content Settings: Tick the related items to add its value/status to the Timer report SMS contents.

Alarm SMS Content Settings: Ticks the related items to add its value/status to the Alarm SMS Contents.

Number Settings

This is to setup the Authorized User Telephone Numbers to receive the Alarm SMS or dial. Tick it stands for while the related event alarm occurrence will send SMS to this number.

Reminder:

Please remember that click "Save" - "Save Settings" button to save it after parameter be written, below pages are the same.

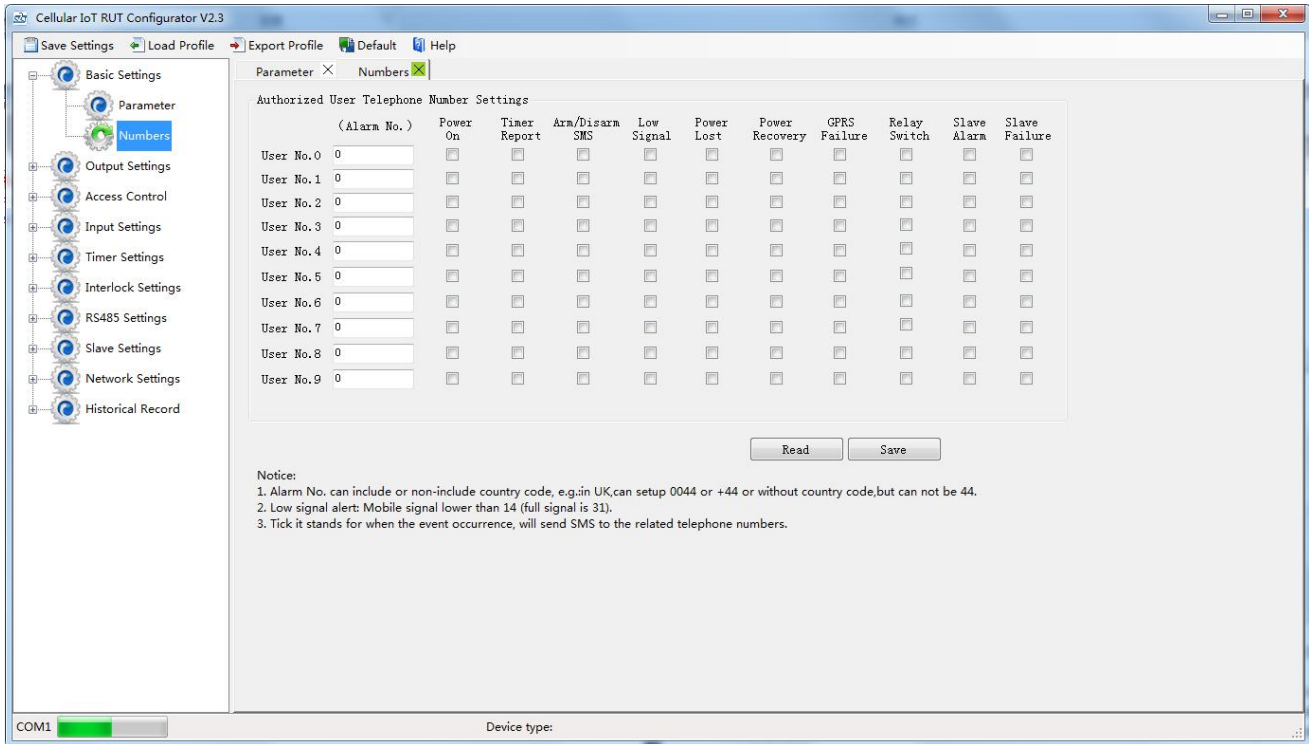

Power On: Tick it stands for while the RTU powered up, will automatically send SMS to this number, include device model, version, description, IMEI, status, signal value etc....

Timer Report: Tick it stands for Timer report SMS will send to this number.

Arm/Disarm: Tick it stands for Arm or Disarm the RTU, will send SMS to this number.

Low Signal: Tick it stands for while GSM/3G/4G Network signal strength lower than 14 will send SMS to this number.

Power Lost: Tick it stands for while external DC Power loss will send SMS to this number.

Power Recovery: Tick it stands for while external DC Power recovery, will send SMS to this number.

GPRS Failure: Tick it stands for while GPRS connection re-try 3 times and still failure will send SMS to this number.

Relay Switch: Tick it stands for while the Digital Solid Relay Output action will send SMS to this number.

Slave Alarm: Tick it stands for the slave tag triggered will send SMS to this number.

Slave Failure: Tick it stands for when slave communication failure alarm verify time arrive, will send SMS to this number.

Digital Solid Relay Output (DOUT) Settings

This page is to setup the Output parameters and definite the output usages. The outputs will be used in the Interlock Page for programmable logic events.

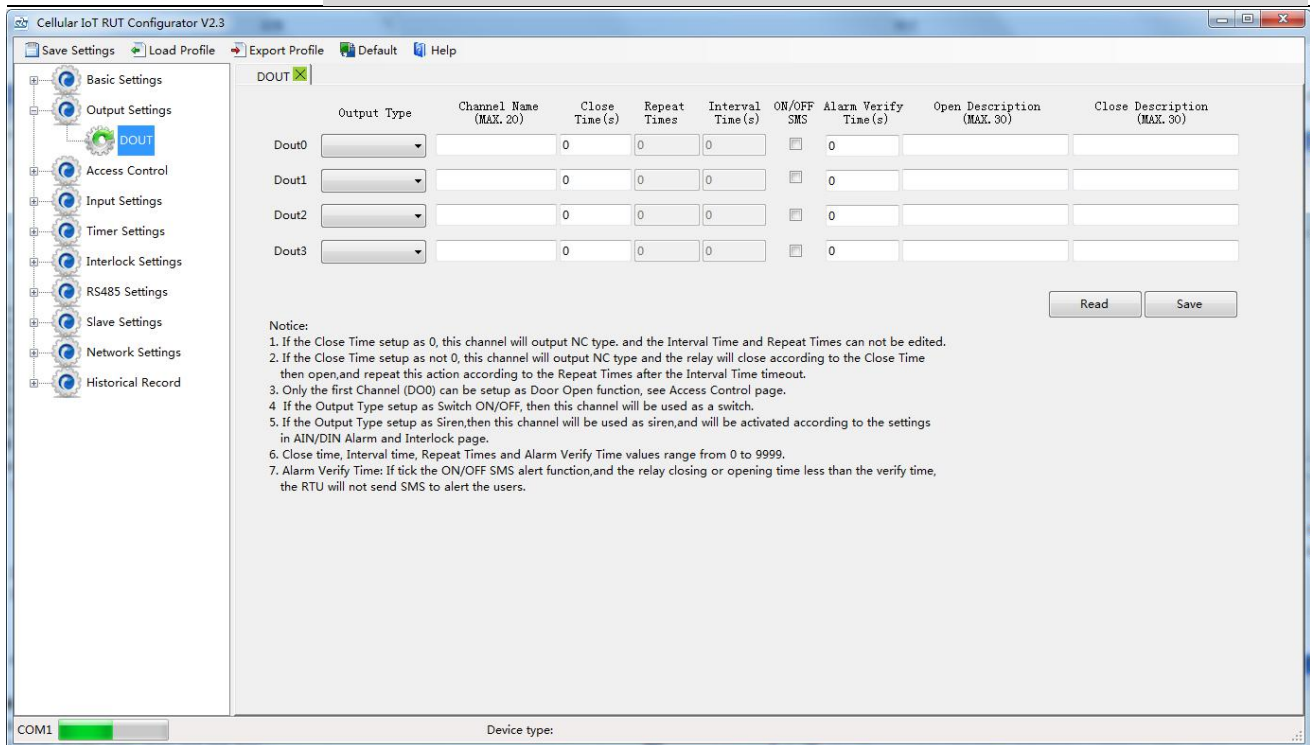

Output Type: Support 3 output types. The user can choose the Output Type for the relay outputs, includes Open Door, Switch ON/OFF, Siren. The relay 2 and 3 only used for Switch ON/OFF; Relay 0 can option as Open Door and Switch ON/OFF; Relay 1 can option as Siren and Switch ON/OFF.

- 1) **Open Door:** Only the first Channel(DO0) can be setup as Open Door, use it for electric lock. If setup as Open Door, then the authorized number calls in RTU, can open the electric Lock directly or output a pulse signal and disarmed the RTU directly. See **Access Control** page about the authorized number.

Notice:

If relay 0 used for Open Door, then can't be action as normal Switch ON/OFF.

Application:

When RTU installed in generator room, many workers out and in, not convenience and safe for everyone taking keys. This function can authorize the person to remotely control the door and disarm the device within appointed time, avoid fault anti-thief alert. After worker maintenance the generator room, can touch the inside Arm/Disarm switch button to arm device, DIN2 can do this.

- 2) **Switch ON/OFF:** For switch on/off device.
- 3) **Siren:** This is for output pulse signal for siren sounds, If setup as Siren, then while the RTU alarm and ticked the Siren function in AIN or DIN trigger pages, then this channel will execute the setting parameters.

Channel Name: to setup the Output Channel name, e.g.: Pump or Motor and so on, in order to identify it in SMS Contents.

Open Description: Stands for when the Relay Open, send what SMS to the authorized numbers;

Close Description: Stands for when the Relay Close, send what SMS to the authorized numbers.

Close Time: Stands for the relay close and last time, default 0 second, means always close.

Repeat Times: Stands for how many times does this relay should to repeat.

Interval Time: Stands for interval how many seconds then the relay repeat the action again.
Match with "Repeat Times" can work as pulse output, unit: second.

ON/OFF SMS: Tick it stands for while the Recovery action, will also send SMS to the authorized numbers;

Access Control Settings

This page is for setting which authorized number at what time can dial to the RTU and let the first channel (DO0) output a pulse output.

Only when the output types of the first channel (DO0) setup as **Open Door** can dial to control it.

It is very useful for serviceman dial to open the electric lock door and disarmed at specified time of the Room. Also this function can be used as authorized number dial in the RTU to output a pulse output or always close then call again open the relay at specified time. In this condition, please setup the output type of DO0 as **Open Door**, and setup other parameters correctly, and remember to setup the **Auto Arm after Disarmed** time as 0 to keep the RTU in Armed Mode if required.

Tick the box ahead the User No. stands for enable the first Authorized number can dial in to let the first channel (DO0) output a pulse output.

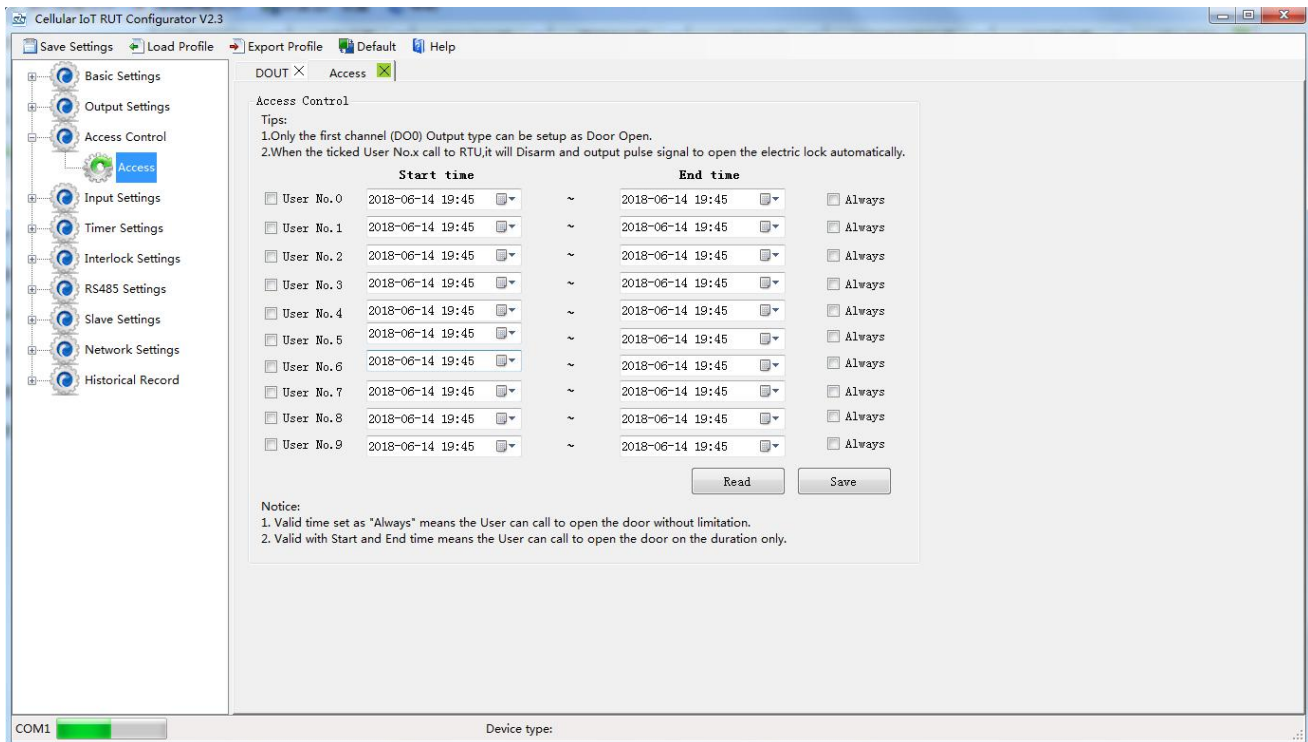

Start Time: Stands for from what time this authorized number can dial in to control it.

End Time: Stands for till what time this authorized number cannot dial in to control it.

Always: Stands for this authorized number can dial in to control it all the time.

DIN Trigger Settings

This page is for setting the digital input alarm conditions and usages.

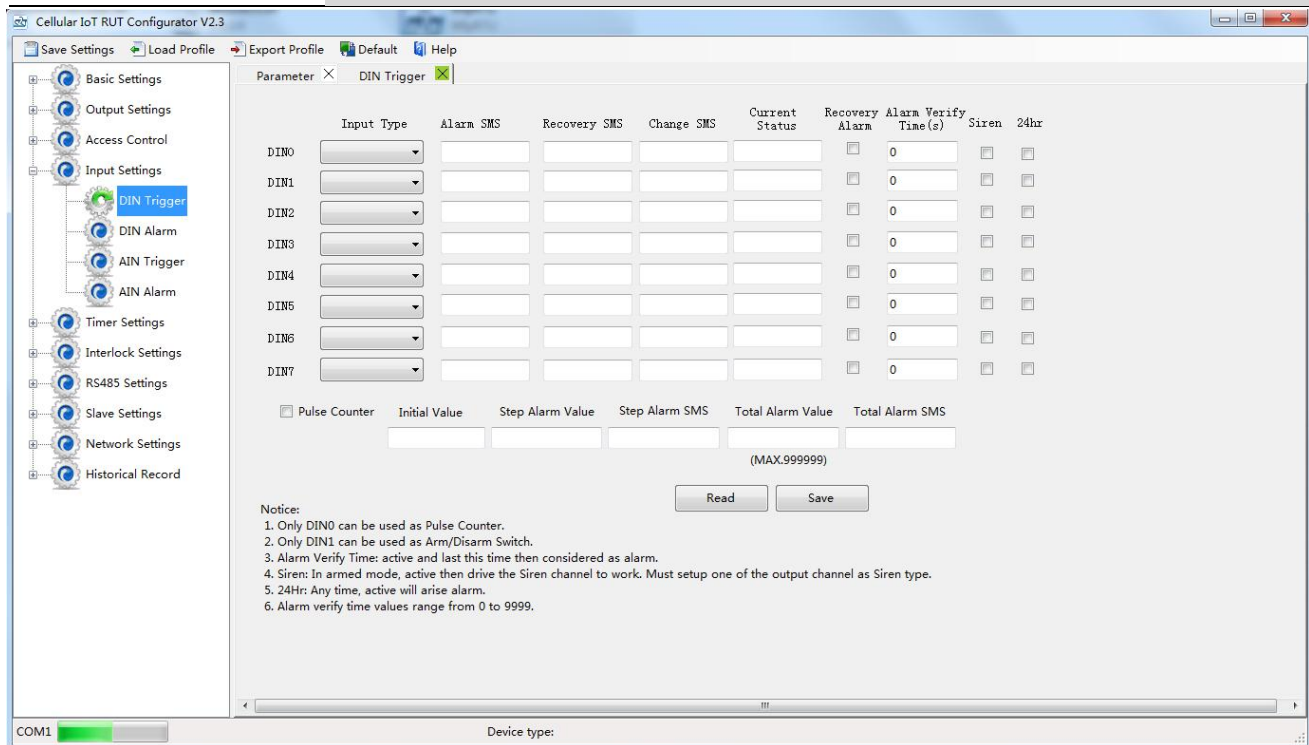

Input Type: The user can choose the input type for related channel. Includes: Counter, Arm/Disarm, NC, NO, Change and Disabled.

- 1) **Disabled:** Not use this channel.
- 2) **NC:** For connecting Normal close type detector, open will alarm.
- 3) **NO:** For connecting normal open type detector, close will alarm.
- 4) **Change:** For connecting normal open or normal close type detector, once the status changed, will be treated as alarm.
- 5) **Counter:** Only the first channel (DIN0) can be used as counter. It can be used for pulse counter usage. Need to tick up the Pulse Counter box to setup initial value and interval alarm value and total alarm value. E.g.: contact a PIR sensor to count how many people pass through the ATM machine and so on.
- 6) **Arm/Disarm:** Only the Second Channel (DIN1) can be used as Arm/Disarm Switch. For connecting a pulse output type switch to Arm or Disarmed the RTU.

Alarm SMS: Under Arm or 24h status, once triggered will send this SMS content to authorized numbers.

Recovery SMS: Under Arm or 24h status, if tick the "Recovery Alarm", when triggered digital input recovery normal will send this SMS content to authorize number.

Change SMS: Under Arm or 24hr status, only when digital input choose "Change" type, once action will send this SMS to authorize number.

Current Status: Stands for input's current status.

Alarm Verify Time: Stands for when the digital input Close or Open last time more than this value, will be treated as a true alarm, if less than this value, then will not alarm.

Siren: Tick it stands for while this digital input triggering, the DO that output type was setup as Siren will execute its output parameters.

24Hr: Tick it stands for no matter the RTU is in Arm or Disarmed mode, this digital input triggered will alarm.

Initial Value: When DIN0 as counter, the value begin to count.

Step Alarm Value: DIN0 as counter, under Arm or 24hr status, when counter value arrive

"Step Alarm Value" will send SMS to authorize number.

Total Alarm Value: When counter value arrive "Total Alarm Value", will automatically refresh it to "Initial Value". Under Arm or 24hr status, will call and SMS to authorize number.

Step Alarm SMS: When step alarm, will send this SMS to authorize number.

Total Alarm SMS: When arrive total max value, will send this SMS to authorize number.

DIN/AIN Alarm Settings

This page is for setup while DIN/AIN alarm, send SMS & Dial to which authorized numbers. Tick it stands for enable to send SMS or dial the related authorized number, see below page is for DIN settings, the AIN Alarm Settings is the same:

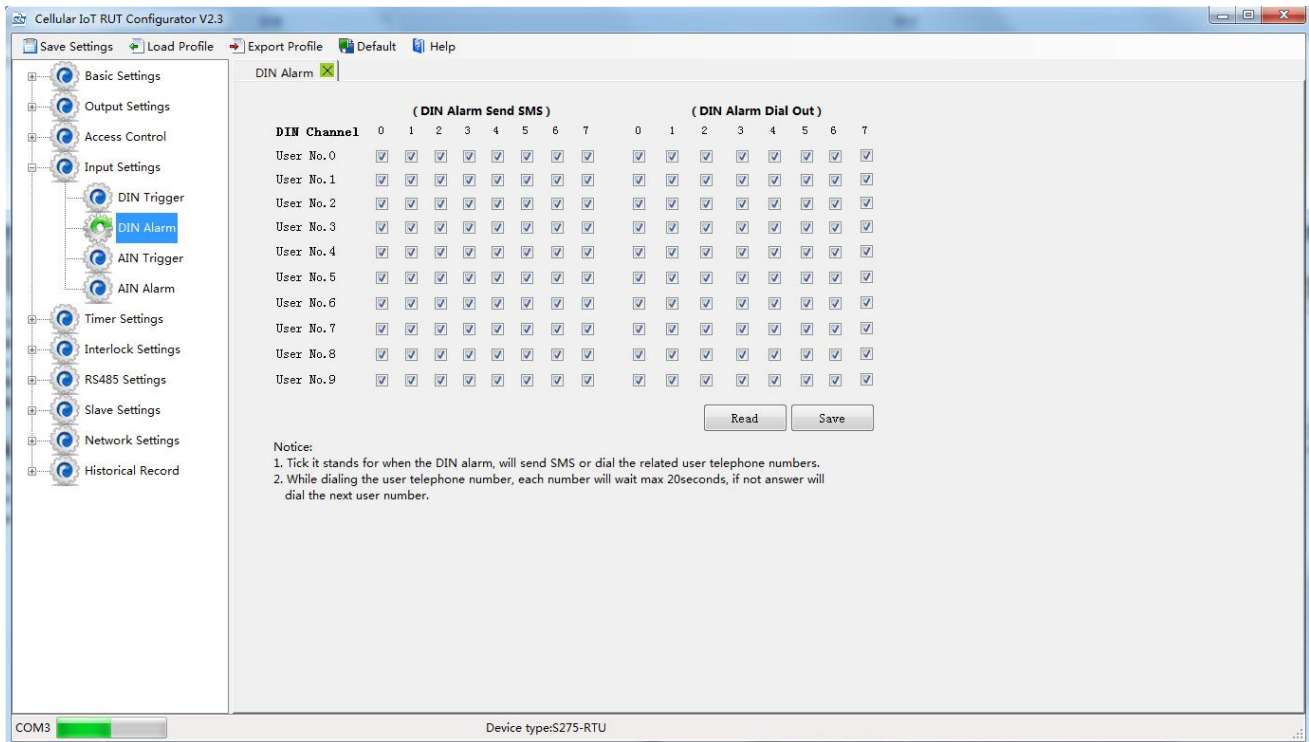

AIN Trigger Settings

This page is to setup the analog input alarm conditions and analog input parameter. AIN can be used for monitoring temperature, current, voltage, power factor, water level, pressure, environment, wind speed... And also one channel temperature and humidity transducer can be connected as below:

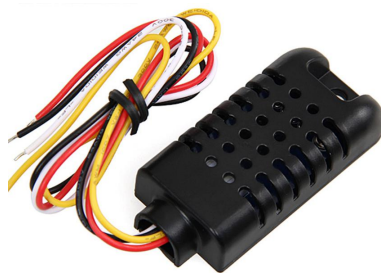

AM2301 PIN Dfinition

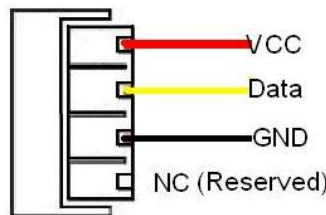

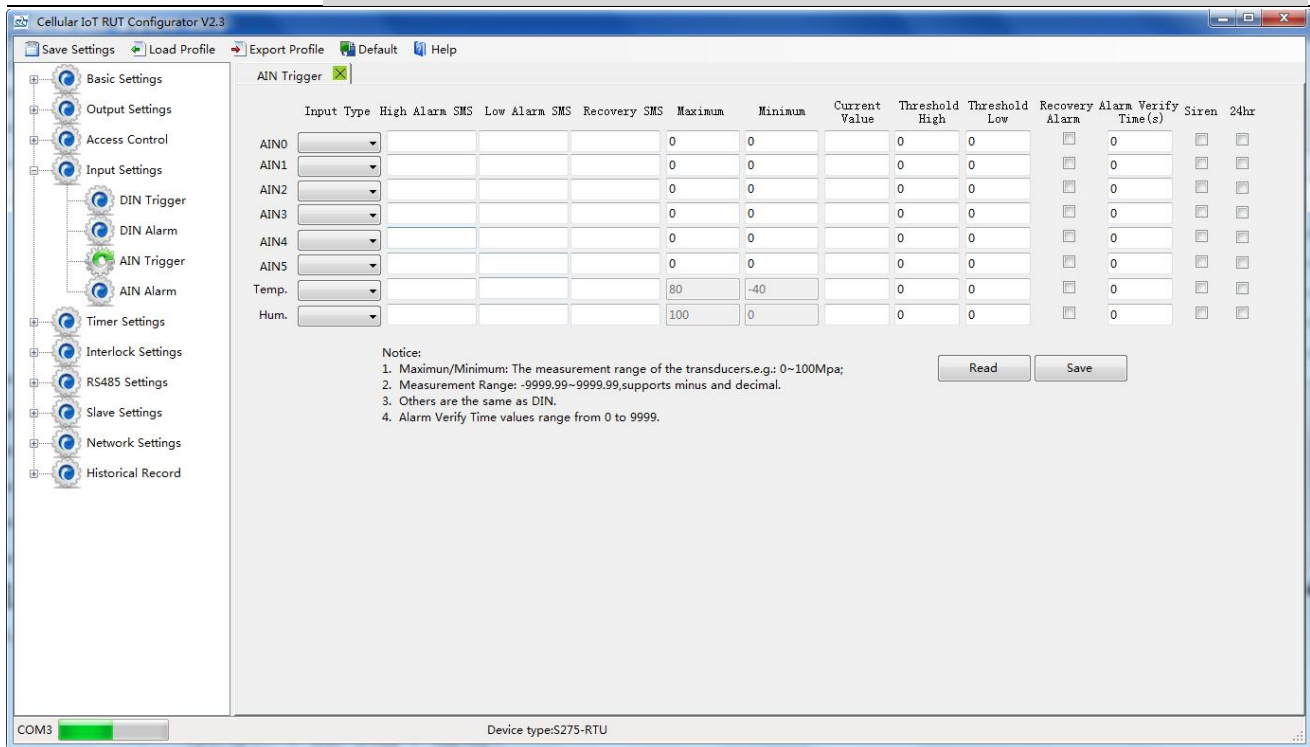

Input Type: The user can choose the input type for related channel. Includes: Disable, 0~5V, 0~20mA, 4~20mA.

- 1) **Disabled:** Not use this channel.
- 2) **0~5V:** For connecting transducers that output voltage 0~5V. Please remember to switch the related channel DIP switch to V side, see **DIP Switch Definitions**.
- 3) **0~20mA:** For connecting transducers that output current 0~20mA, Please remember to switch the related channel DIP switch to A side, see **DIP Switch Definitions**.
- 4) **4~20mA:** For connecting For connecting transducers that output current 0~20mA, Please remember to switch the related channel DIP switch to A side, see **DIP Switch Definitions**.
- 5) **Temperature and Humidity:** Enable/Disable support. Only accept AMS230x series sensor, the temperature maximum is 80, minimum is -40, and Humidity maximum is 100, minimum is 0, cannot change them.

High Alarm SMS: Under Arm or 24h status, once current value higher than threshold high value will send this SMS content to authorized numbers.

Low Alarm SMS: Under Arm or 24h status, once current value lower than threshold low value will send this SMS content to authorized numbers.

Recovery SMS: Under Arm or 24h status, if tick the "Recovery Alarm", when current value recovery normal will send this SMS content to authorize number.

Maximum: The transducer's maximum measure range. E.g.:100 Celsius degree. Usually it can be found out at the transducer's specification.

Minimum: The transducer's minimum measure range. E.g : -50 Celsius degree. Usually it can be found out at the transducer's specification.

Current Value: Stands for input's current value of the transducers.

Threshold High: The high value(reached) need to alarm; Example: set 50Celsius degree to alert.

Threshold Low: The low value(reached) need to alarm; Example: set -30Celsius degree to alert.

Recovery Alarm: Tick it stands for when the analog input recovery, will send SMS to the authorized numbers.

Siren: Tick it stands for while this input triggering, the DO that output type was setup as Siren

will execute the its output parameters.

24Hr: Tick it stands for no matter the RTU is in Arm or Disarmed mode, this input triggered will alarm.

Timer Settings

This page is for setup hour timer and periodically timer, it is useful for scheduling when to execute what action automatically or it with repeat this action according to the interval time. Total can program 10 scheduling events. Tick it stands for enable this timer event:

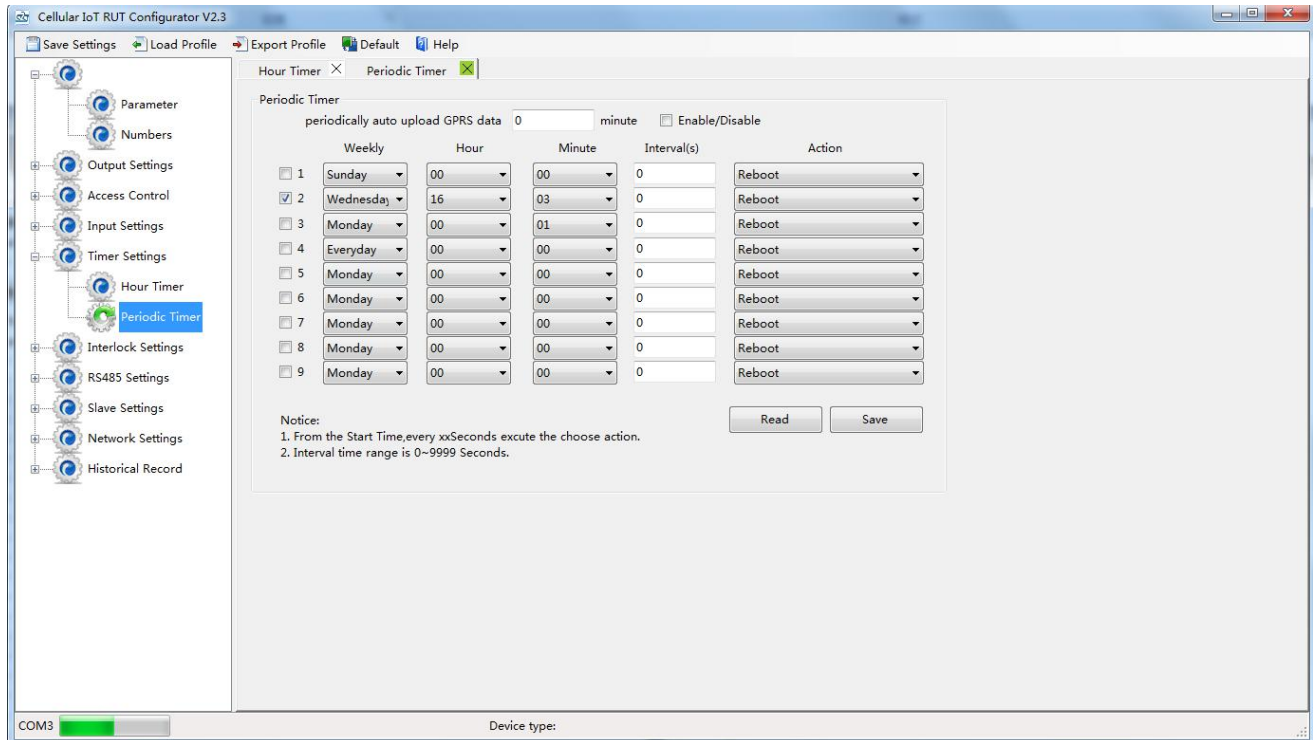

Reminder:

When GPRS/3G/4G data transmission protocol is King Pigeon IoT RTU Protocol, the periodically auto upload default enable and upload every 5 minutes.

Tick stands for enable this timer function, otherwise is disable.

Weekly+Hour+Minute: Stands for what day and at what time does the RTU should start to execute the action and interval how many seconds then repeat to execute the action.

Interval: Stands for interval how many seconds does the RTU should repeat to execute the action.

If setup it as 0, then this event will not be repeated.

Action: Stands for what action does the RTU should to execute at the specified time.

Question: Have set the timer SMS report, but finally not get the SMS.

Solution: Have no ticked the "Timer Reporting SMS Content" in first Basic Parameter Settings page.

Interlock Settings

This page is for setup if what happen, then what action does the RTU should execute, it is a programmable logic events. Total can program up to 40 logic events for automatically control purposes.

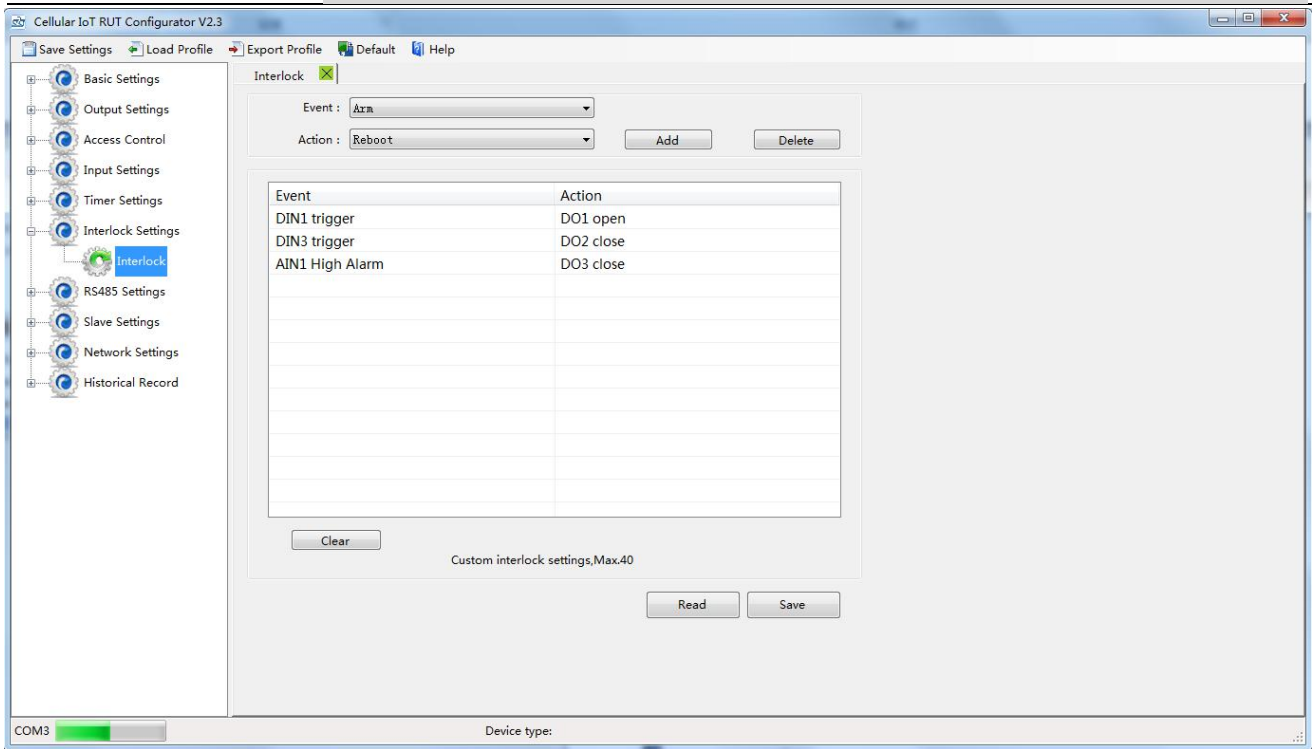

Event: Stands for if this occurrence.

Action: Stands for then what action does the RTU should execute.

RS485 Serial Port Settings

This page is for setup the serial port parameters. Over the RS485, the S272 RTU can be used as Modbus RTU Slave and transparent transmission.

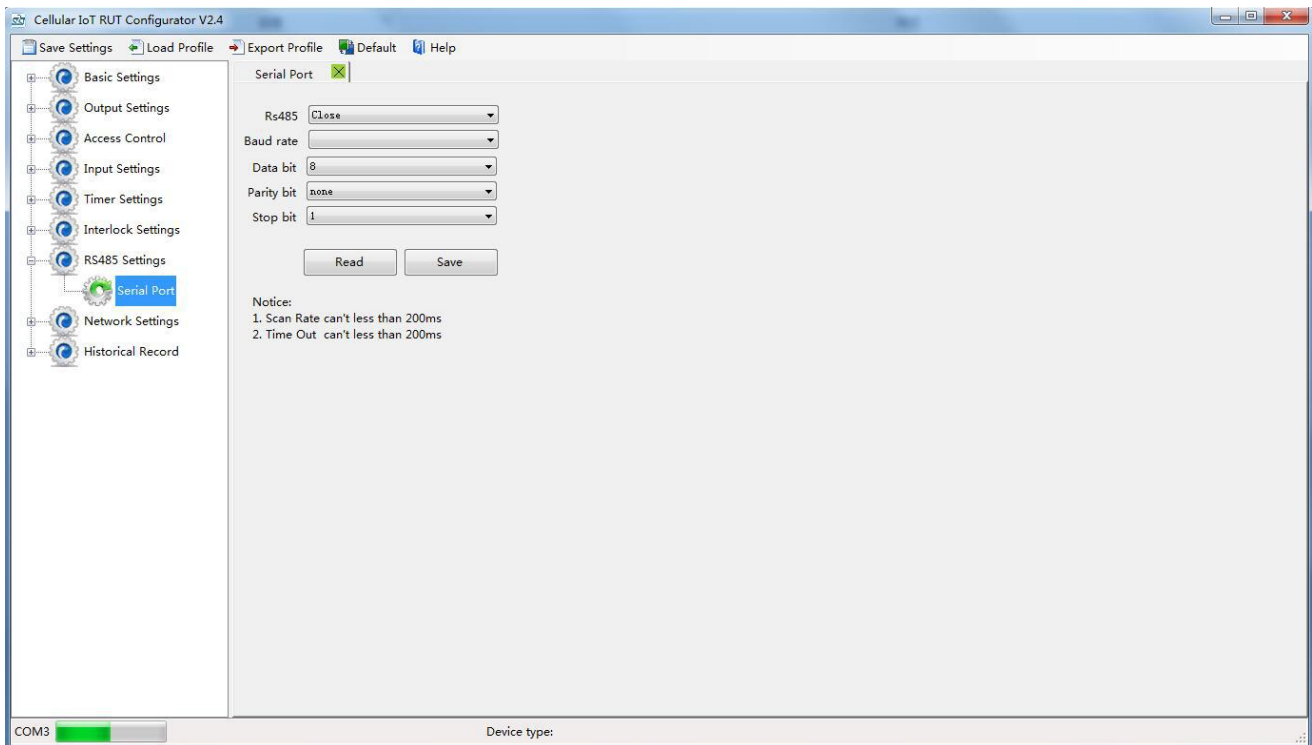

Modbus RTU Slave: Stands for the RS485 used for Modbus RTU Slave

Baud Rate: 1200/2400/4800/9600/19200/38400/57600/115200 optional.

Data Bit: 8 bit.

Parity Bit: None, Even and Odd optional.

Stop Bit: 1 or 2 stop bit optional.

Modbus RTU Slave function:

When RS485 as Modbus RTU Slave, can be connected to HMI, SCADA, DCS, PLC... as below:

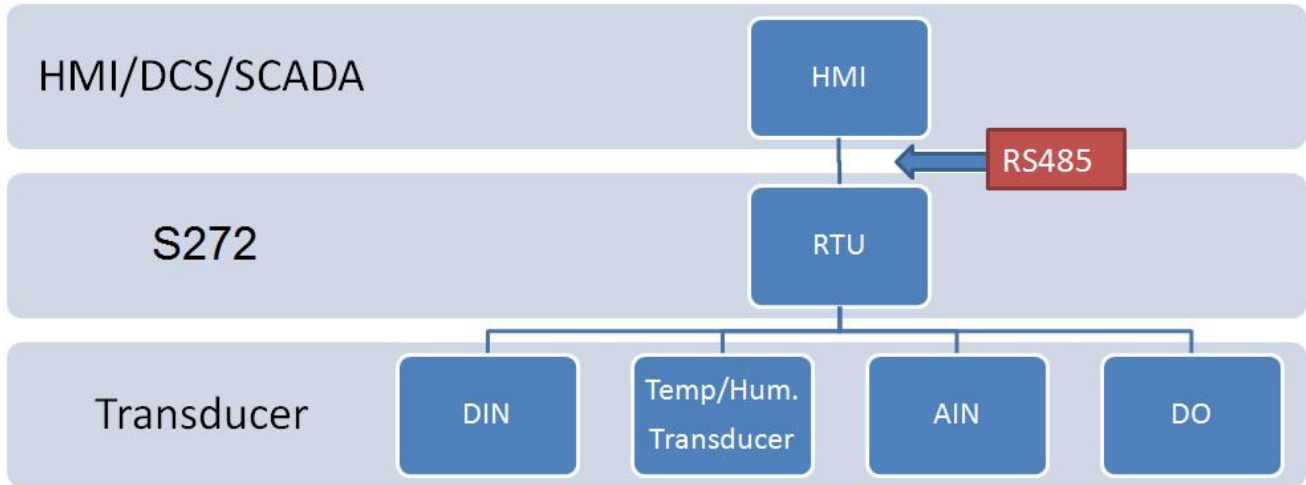

RTU I/O Register List and function code:

Read Input Coil (Function Code 02: Read Coil)		
Register Address (Decimal)	Definition	Description
0	RTU DIN0	DIN0 value, when dry contact, NC=1, NO=0; When wet contract, 0~0.5V=1, 3~24V=0
1	RTU DIN1	DIN1 value, when dry contact, NC=1, NO=0; When wet contract, 0~0.5V=1, 3~24V=0
2	RTU DIN2	DIN2 value, when dry contact, NC=1, NO=0; When wet contract, 0~0.5V=1, 3~24V=0
3	RTU DIN3	DIN3 value, when dry contact, NC=1, NO=0; When wet contract, 0~0.5V=1, 3~24V=0
4	RTU DIN4	DIN4 value, when dry contact, NC=1, NO=0; When wet contract, 0~0.5V=1, 3~24V=0
5	RTU DIN5	DIN5 value, when dry contact, NC=1, NO=0; When wet contract, 0~0.5V=1, 3~24V=0
6	RTU DIN6	DIN6 value, when dry contact, NC=1, NO=0; When wet contract, 0~0.5V=1, 3~24V=0
7	RTU DIN7	DIN7 value, when dry contact, NC=1, NO=0; When wet contract, 0~0.5V=1, 3~24V=0

Read Input Register (Function Code 4: Read Input Register.)			
Register Address (Decimal)	Definition	Data Type	Description
0	RTU AIN0	32 Bit Signed ABCD 2 Byte in Modbus protocol	AIN0 value, real value= AIN0 value/100

2	RTU AIN1		AIN1 value, real value= AIN1 value/100
4	RTU AIN2		AIN2 value, real value= AIN2 value/100
6	RTU AIN3		AIN3 value, real value= AIN3 value/100
8	RTU AIN4		AIN4 value, real value= AIN4 value/100
10	RTU AIN5		AIN5 value, real value= AIN5 value/100
12--13	(reserved, not work)
14	RTU Power	16 Bit Unsigned AB 1 Byte in Modbus protocol	External power voltage, real value= Power value/100
15--23	(reserved, not work)
24	RTU Temperature	16 Bit Signed AB 1 Byte in Modbus protocol	AM2301 Temperature value (*100), real value= Temperature value/100
25	RTU Humidity	16 Bit Signed AB 1 Byte in Modbus protocol	AM2301 Humidity value (*100), real value= Humidity value/100.
26	RTU DINO Count Value	32 Bit Unsigned	This value Enable when DINO as counter mode

Read and Write Holding Coil (Function Code 1, Function Code 5, Function Code 15.)

Register Address (Decimal)	Definition	Description
0	RTU DO0	DO0 Value, Read/Write, 1=Close, 0=Open
1	RTU DO1	DO1 Value, Read/Write, 1=Close, 0=Open
2	RTU DO2	DO2 Value, Read/Write, 1=Close, 0=Open
3	RTU DO3	DO3 Value, Read/Write, 1=Close, 0=Open
4--63	(reserved, not work)	

 **Transparent Transmission:**

The RS485 can be used as transparent transmission, transmit the device data on this serial port to GPRS/3G/4G, the device not deal with or store any data, only do as a data transmit channel, converter serial port to TCP/IP.

This function can be used for connecting PLC, Remote I/O data acquisition module, Smart meter, Power monitoring moduel, Smart transducer, Diesel generator, Accumulator battery monitoring system...

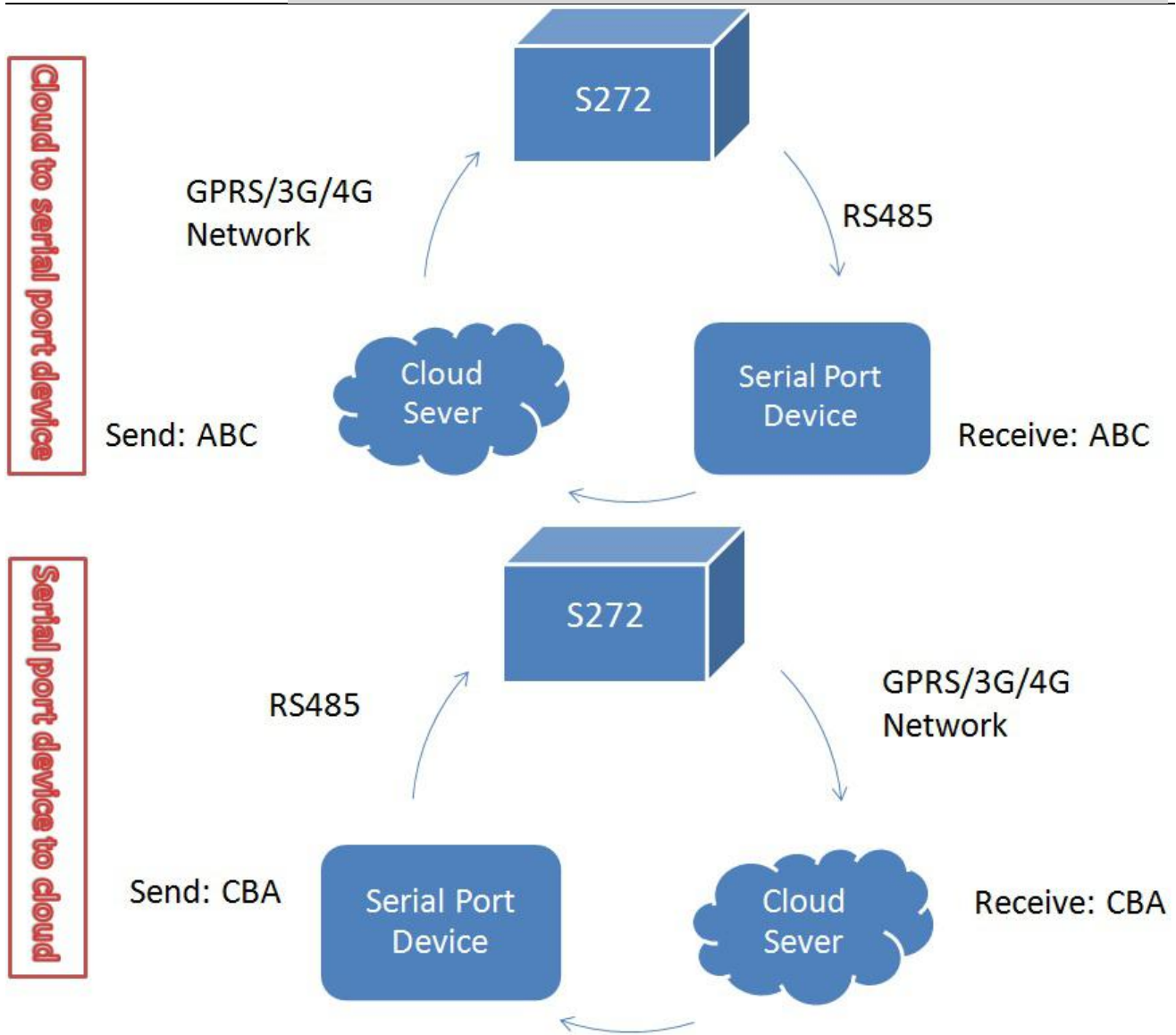

Network Settings

This page used for setting device parameters connect to networks. The device can be compatible with many third party upper computer system. And it can communicate with monitoring software or cloud via GPRS/3G/4G as below:

- 1) Modbus RTU Protocol, means Modbus RTU over TCP, communication with upper computer system. For example, connect to www.my-m2m.com cloud server. Domain: modbus.dtuip.com, Port: 6651.
- 2) Modbus TCP Protocol, communication with upper computer system. For example, connect to www.my-m2m.com cloud server. Domain: modbus.dtuip.com, Port: 6655.
- 3) King Pigeon IoT RTU protocol, transmit the King Pigeon IoT protocol on TCP, to communication with upper computer system. Advantage is when device abnormal, can send data to upper system automatically, not waiting for polling, then answer. For example, connect to www.rtu-m2m.com cloud server.

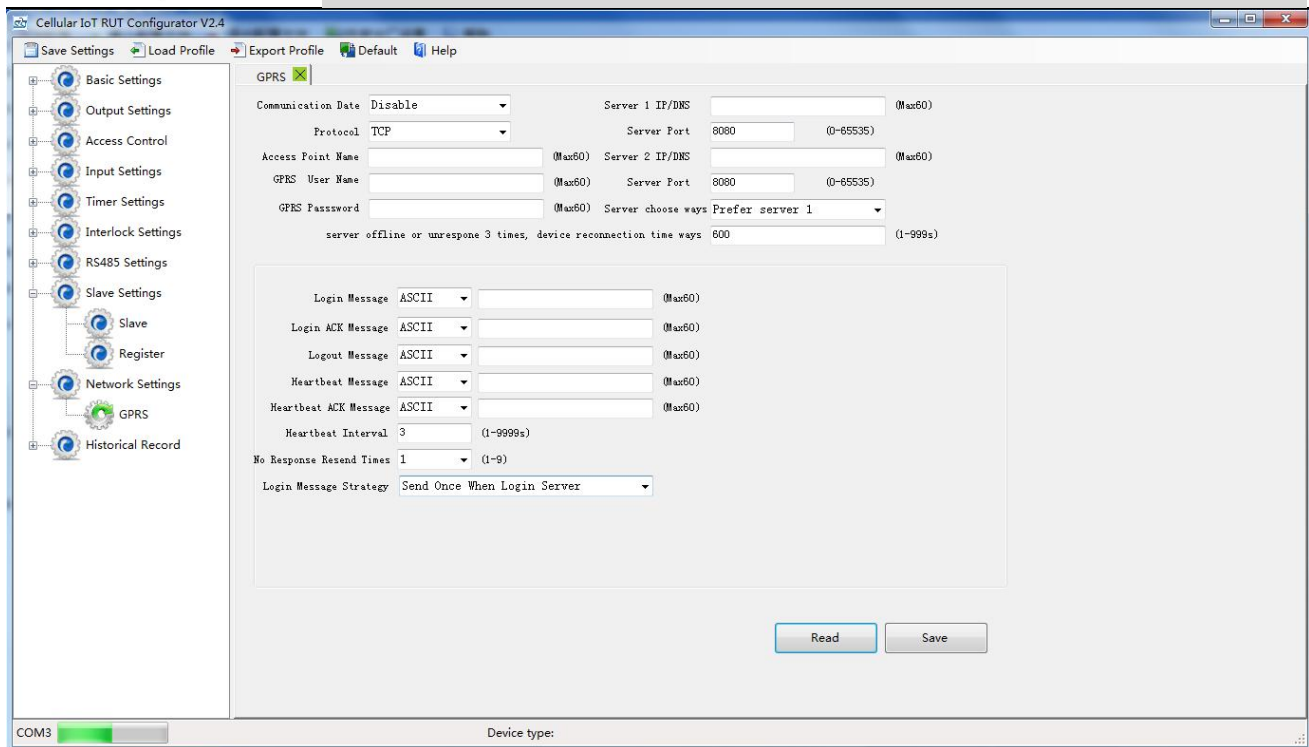

Communication Data: "Disable", "Modbus RTU protocol", "IoT RTU protocol" or "Modbus TCP protocol" optional.

Protocol: TCP or UDP optional.

Access Point Name: APN, GSM operator provide.

GPRS User Name: User Name, GSM operator provide.

GPRS Password: Network password, GSM operator provide.

Sever 1/2 IP/DNS: Server IP address or DNS.

Port: Stands for the server's port.

Server Choose Ways: Only support "Prefer server 1" function, no "Both connection" now. When server 1 disconnect, will connect to server 2 automatically.

Server Offline 3 times, Reconnection Time: Connecting server fail 3 times, then the interval time of next time reconnecting

Login Message: Server register handshake protocol package. When transparent transmission or Modbus protocol, this item used for device ID, provided by cloud. Contact King Pigeon sales if need to connect www.my-m2m.com cloud server.

Login ACK Message: Once set, device need response within 10 seconds after device send login message, otherwise it will continue send login message according to "Reconnection Times", still not response will offline once time, then try to reconnect, according to "Server Offline 3 Times, Device Reconnection Time".

Logout Message: Once server send to device, device will be offline.

Heartbeat Message: Heartbeat content to avoid network offline.

Heartbeat ACK Message: Once set, device need response within 6 seconds after device send heartbeat message, otherwise it will continue send login message according to "Reconnection Times", still not response will offline once time, then try to reconnect, according to "Server Offline 3 Times, Device Reconnection Time".

Heartbeat Interval: Network keep online heartbeat interval time.

No Response Resend Times: After setting heartbeat and login message, if server no response, the times which server will send data.

Login Message Strategy: "Send Once When Login Server", "Plus It In Front Of Every Packet", "Both Of Them" optional. "Plus It In Front Of Every Packet" when data transmission.

Historical Record

The device inbuilt 8G SD card, store alarm and historical records. For saving historical records, need to set the saving historical records interval time in "Periodically Timer" page.

For historical record, once it full, will automatically remove the earlier records for new records. And can save as CS format for other purpose usage.

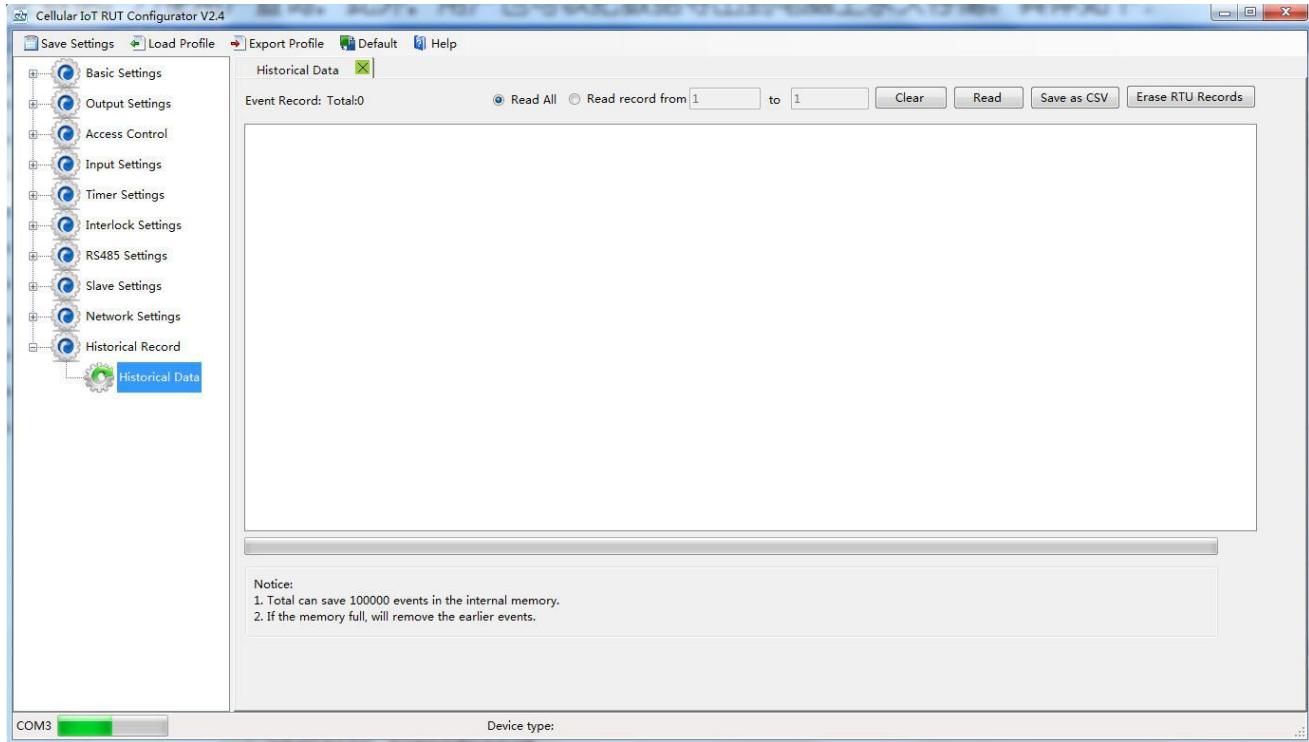

Total: Display device current historical records qty, "Read All" or "Read Record from xx to xx" optional.

Clear: Clear the screen.

Read: Read historical records.

Save as CSV: Historical records export as CSV file.

Erase RTU Records: Click this button will erase all device historical records, be careful.

7. Example Of Applications

Device working self-checking:

(1) Under setting mode, switch Dip to "Set"---->Switch device on---->Running configurator, choose port and password enter into software basic parameter settings---->Click "Read the computer time"---->Then click "Write the RTU time" for device time setting. At the same time, tick "v" for "Arm automatically when power on", then click "Save" button as below:

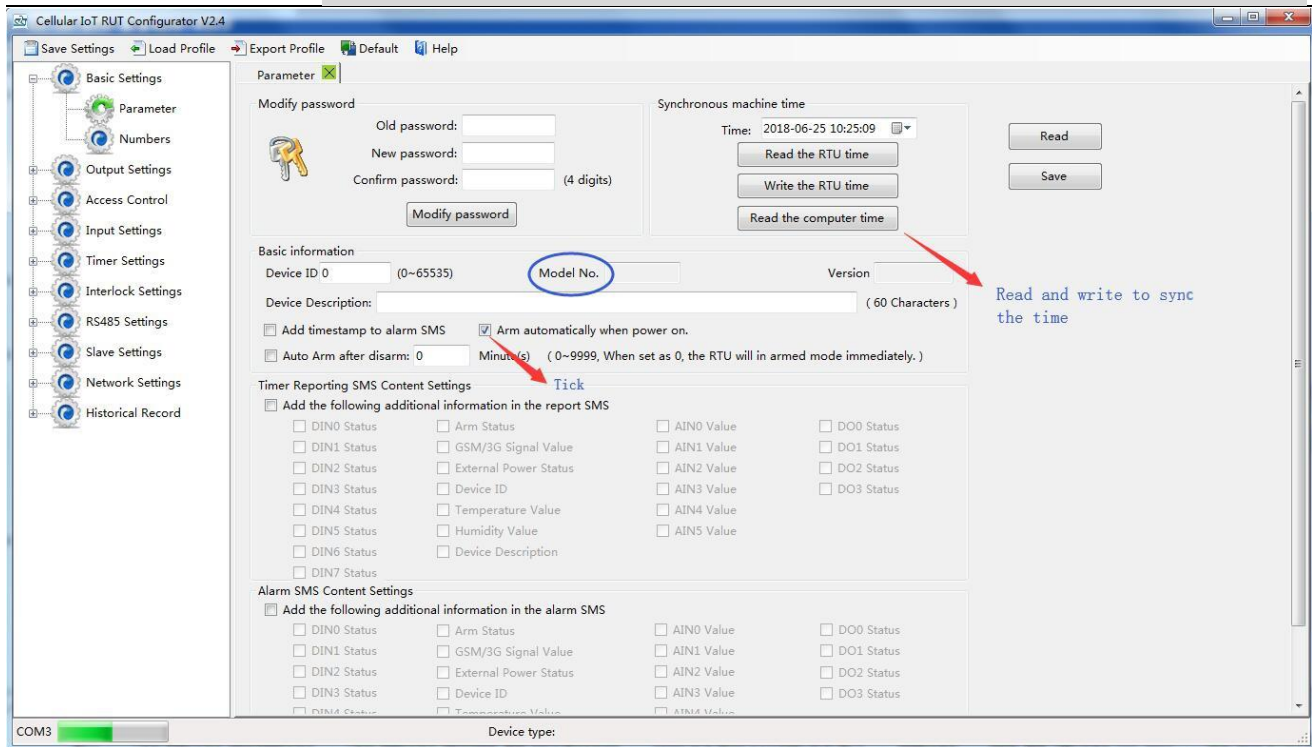

(2) Under "Number Settings" page, write authorize number and tick the times needed. For example, if need power on, external power off/recovery SMS, then tick and write as below:

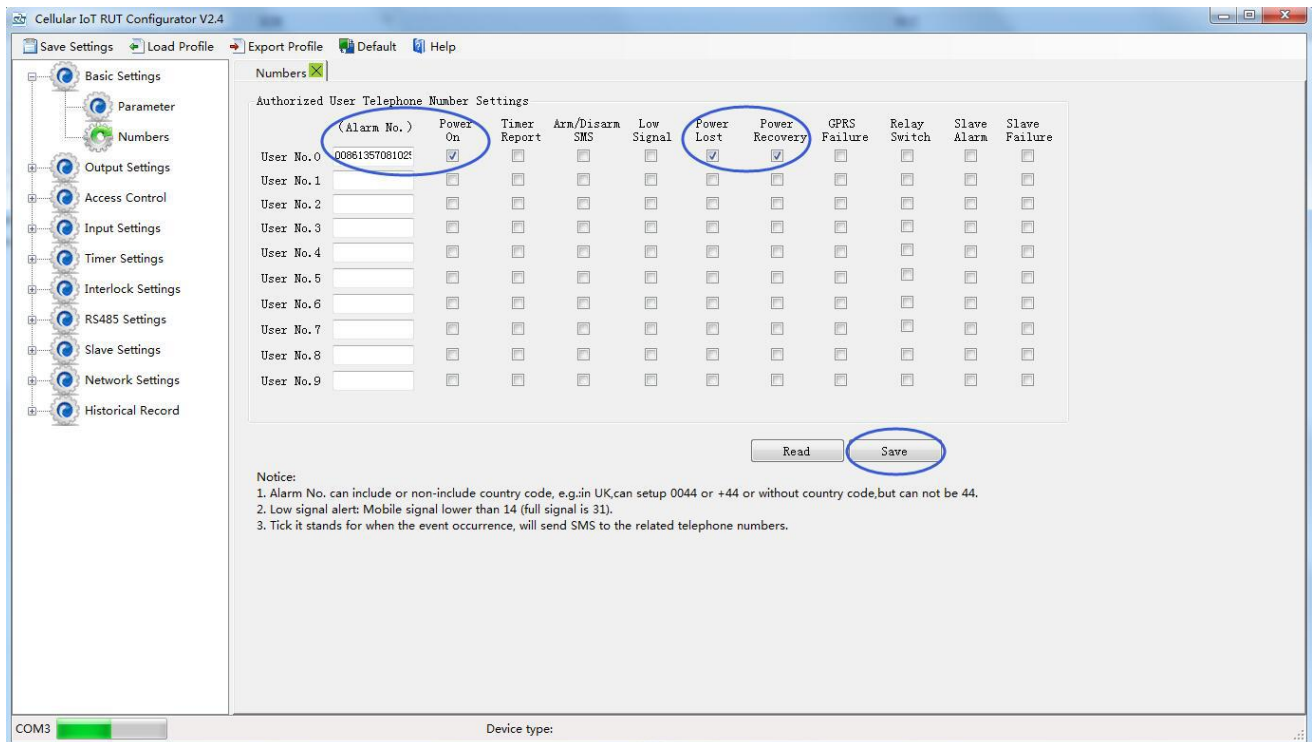

(3) Click "Save Settings"---->Switch device off---->Switch working mode to "Run"---->Put it SIM card and switch device on. 1~2 min after SIM card register network, power on SMS should be received---->The cut the external power, the power lost SMS should be received---->Connect the power support to device again, then power recovery SMS should be received. Thus, the device communication self-checking finished.

Device connect analog transducer:

If AINO need to connect a temperature transducer, transducer output 4~20mA signal, measurement range:

-40~100°C, when temperature last 2 seconds higher than 35°C need to alarm, last 2 seconds lower than 20°C also need a alarm, then set as below:

Mode	Analog Input Type					
	0	1	2	3	4	5
Set	V	V	V	V	V	V
Run	mA	mA	mA	mA	mA	mA

(1) Switch device off, then switch AIN0 input type to "mA";

(2) Wire connect temperature transducer to AIN0 input as below:

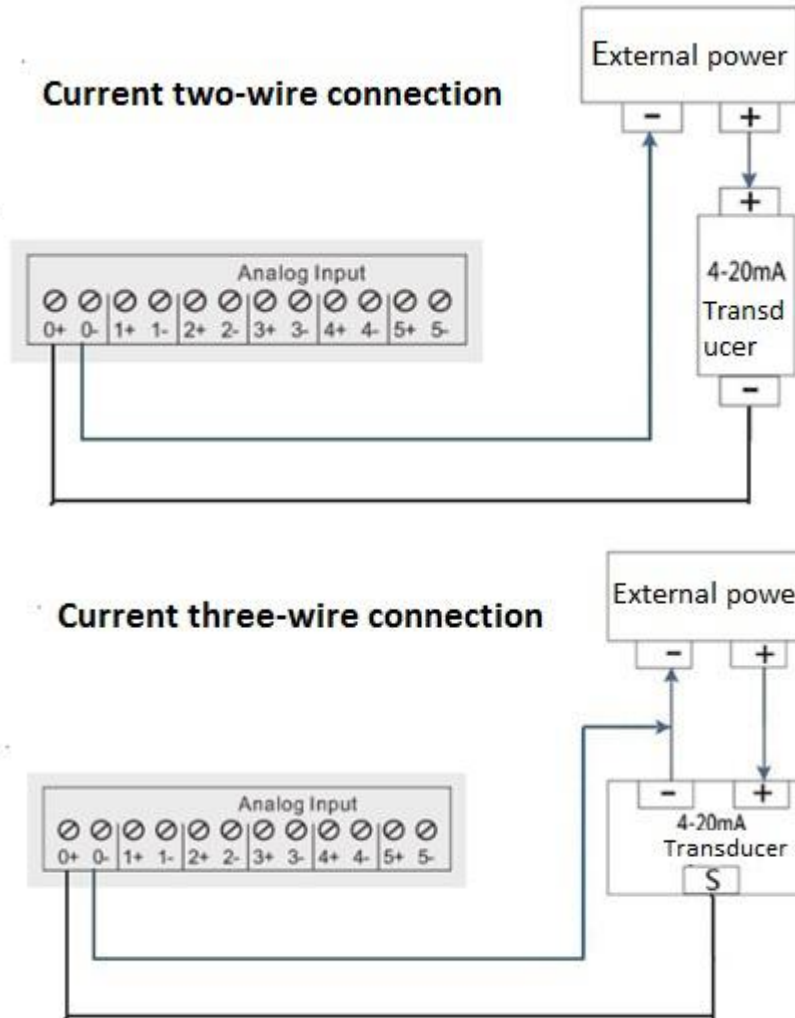

(3) Basic setting according (1) and (2) in "Device working self-checking";

(4) Enter into "AIN Trigger" page---->Set input type to "4~20mA"---->Write "High/Low Alarm SMS"---->"Maximum": 100, "Miximum": -40, "Threshold High": 35, "Threshold Low": 20, "Verify Time": 2. If still need recovery alarm SMS, then need to tick "Recovery Alarm", and write content in "Recovery SMS"---->After that, click "Save" as below:

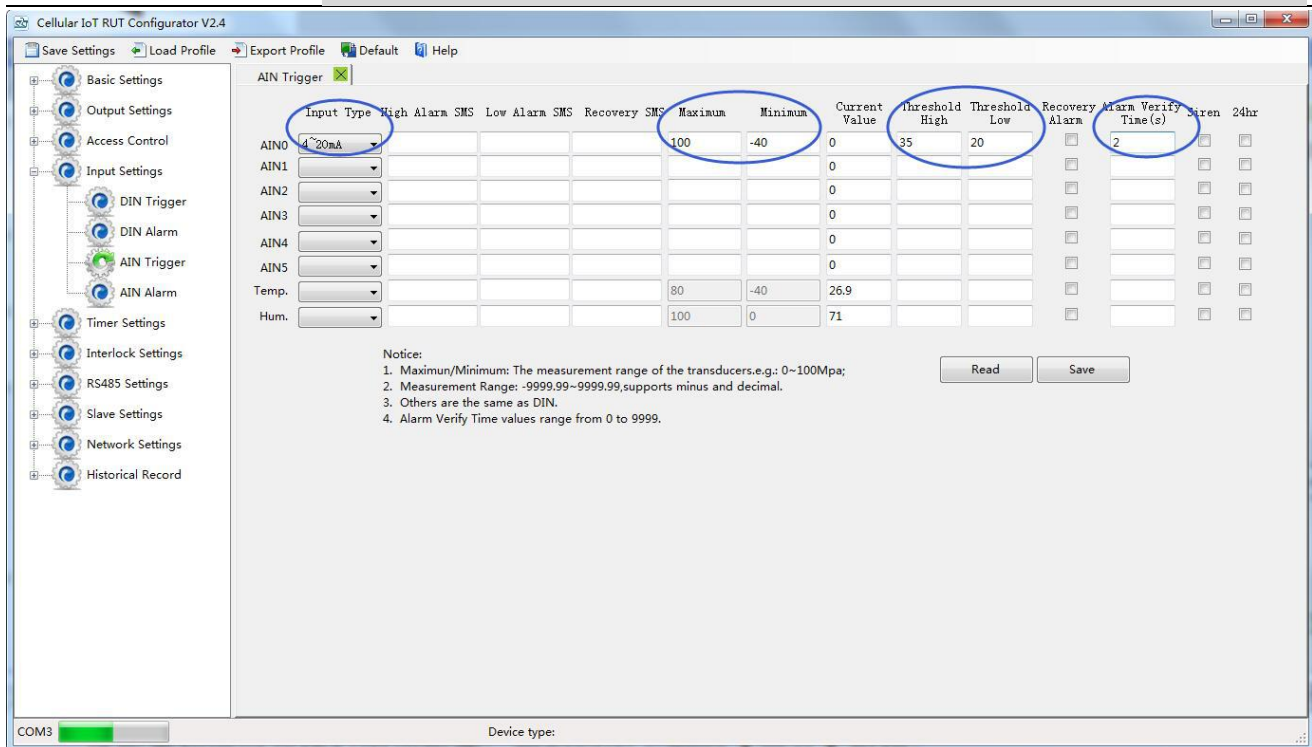

(5) In "AIN Alarm" page, tick the corresponding items for authorize number. For example, when AIN0 alarm, will can and send SMS to authorize number "0" , remember to click "Save" as below:

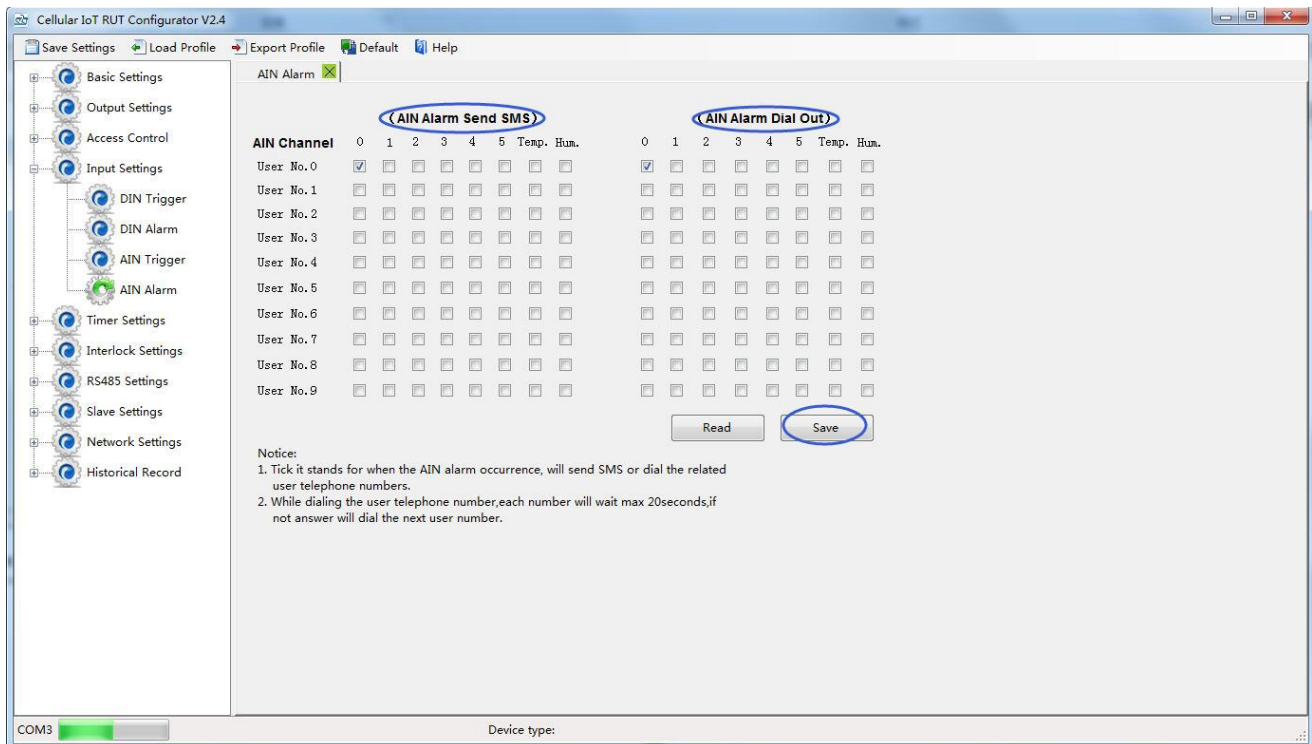

(6) Click "Save Settings" in the menu, then switch device off;

(7) Switch DIP mode to "Run", working mode as below:

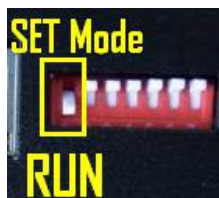

(8) Switch the device on, then device enter into working mode.

Application:

When monitoring cabinet temperature, if higher than 38°C, need to start the cabinet fan; If lower than 25°C, need to close the fan.

Need: Temperature/Humidity transducer AM2301 and 1 channel relay output, if choose the first relay DO0, the set as below:

(1) Switch device off---->connect temperature/humidity transducer to T/H port---->connect the cabinet fan to DO0 output as below:

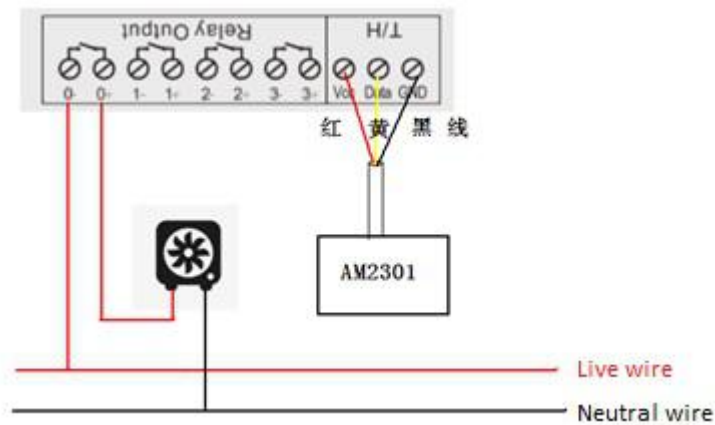

(2) Basic setting according (1) and (2) in "Device working self-checking";

(3) In "Output Settings" page, set first relay DOUT0, output type: Switch on/off, channel name: cabinet fan, close time: 0, 0 means always close. Click "Save" button as below:

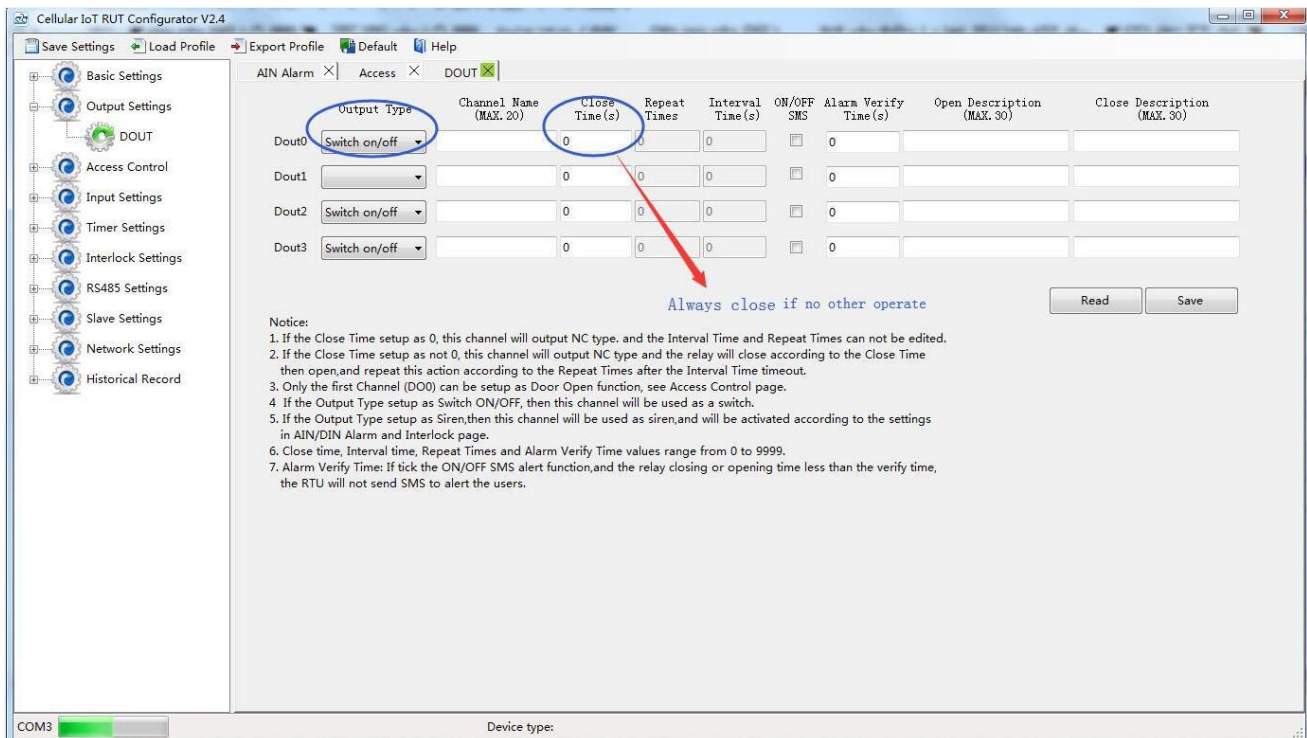

(4) In "AIN Trigger Setting" page, set temperature type "Enable"---->Humidity and AIN0~7 choose "Disable" if not use---->Set corresponding alarm SMS content---->Threshold high: 38 and Threshold low: 25---->Recovery and verify time according to need---->Click "Save" button as below:

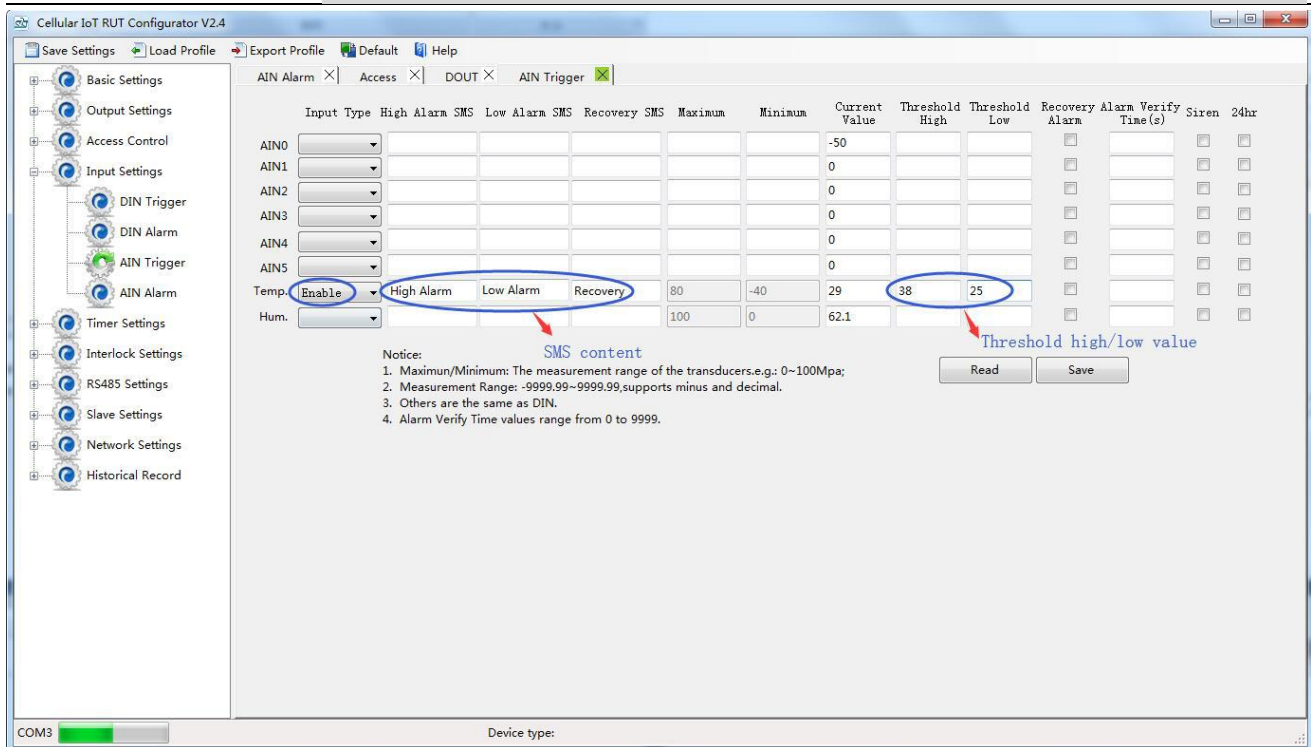

(5) In "Interlock Settings" page, Event choose "Temperature high alarm", Action: "DO0 close"---->Click "Add" button, stands for when temperature high than 38°C, device will close DO0 to start the cabinet fan; Same operate for low alarm setting, then temperature lower than 25°C, device will open DO0 to close the fan automatically---->Click "Save" button as below:

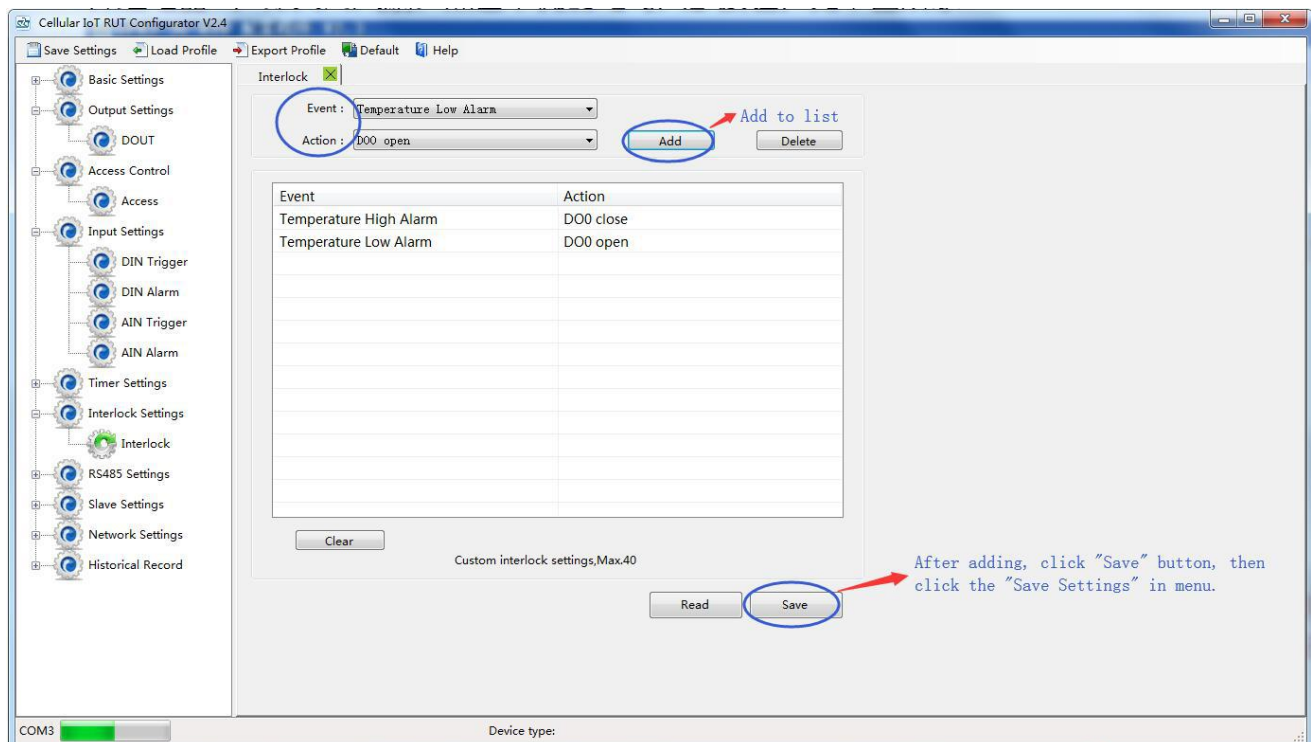

(6) Click "Save Settings" button, then switch device off;

(7) Switch the DIP mode to "Run";

(8) Switch the device on, enter into working mode.

RS485 connected as Modbus RTU Slave:

Device support Modbus RTU slave function, can connect to HMI, SCADA, DCS, MES system. It can be used for field data acquisition, remote SMS alarm, remote dial alarm and GPRS/3G/4G to cloud...

For example, when device as Modbus RTU slave, connect to HMI as below:

- (1) Connect device to HMI via RS485 port, set HMI RS485 port parameter;
- (2) Basic setting according (1) and (2) in "Device working self-checking";
- (3) In "Basic Parameter Settings" page, set "Device ID", range is 1~247 in Modbus protocol as below:

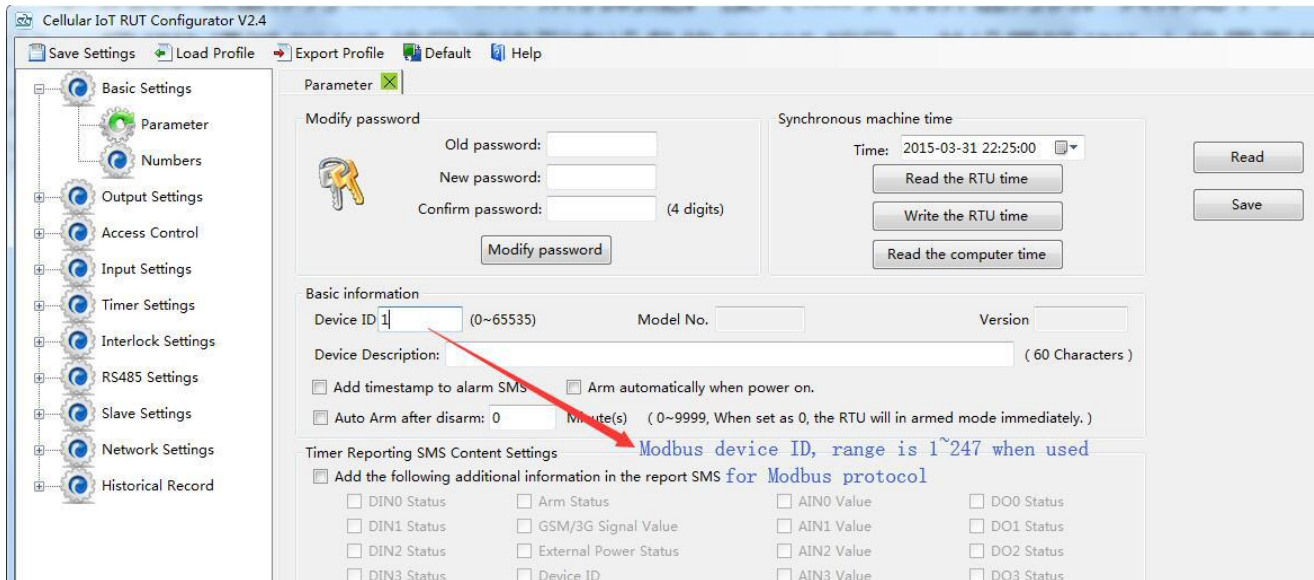

(3) In "Serial Port" setting page, set device parameter as below:

- A) RS485 used as "Modbus RTU Slave";
- B) Baud Rate, Data Bit, Parity Bit, Stop Bit setting should be corresponding with HMI, otherwise communication will be failure. If multi Masters, all Masters parameter should corresponding with device;
- C) Click "Save" button.

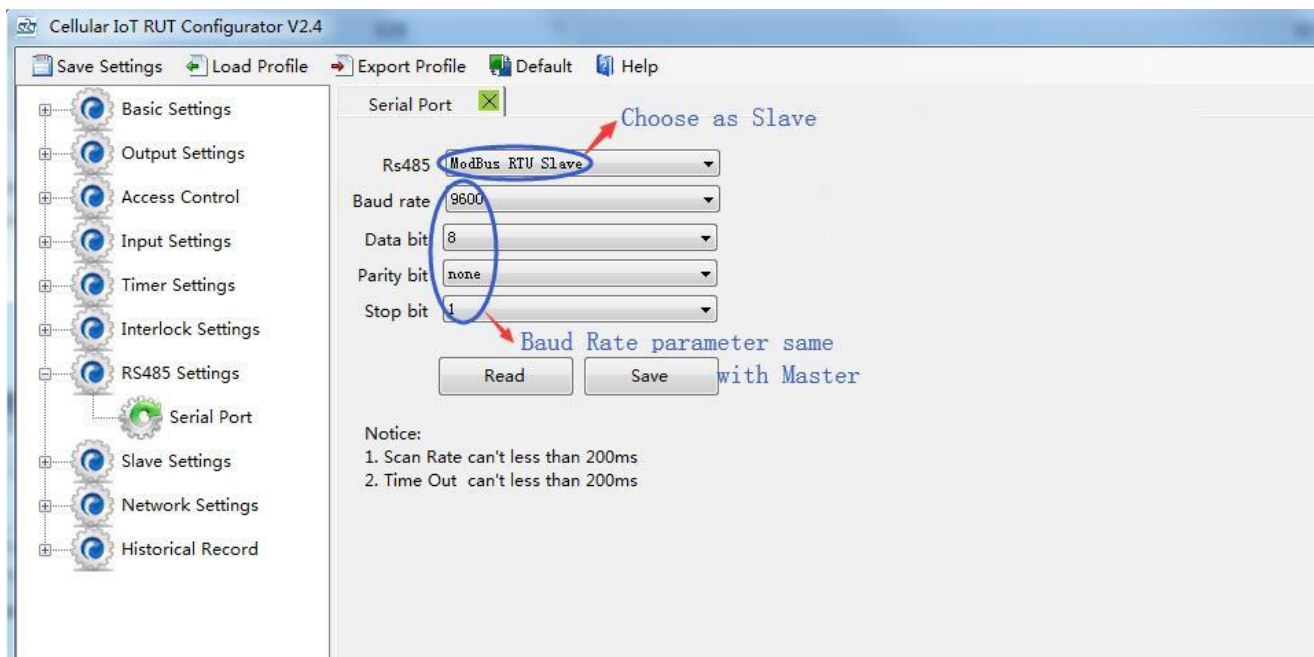

(5) Click "Save Settings" in the menu, switch the device off;

- (6) Switch DIP mode to "Run";
- (7) In HMI configurator software, set the Modbus RTU Register address of device. Refer to [RS485 Serial Port Setting---->Modbus RTU Slave Function---->Device I/O Register Address and Function code];
- (8) Switch the device on, enter into working mode, device running according parameter setting.

Transparent Transmission As DTU:

Device can support data transparent transmission: DTU function. Could server transmit data to device via GPRS/3G/4G, device will transfer the data to RS485 port directly without deal with. Once device receive data from RS485, also transmit to cloud server directly via GPRS/3G/4G, refer to "Serial Port Transparent Transmission". When device RS485 port no need mapping slave, or connect to others which is not standard Modbus RTU protocol, then can choose transparent transmission as below:

- (1) Items connect to device via RS485, set RS485 port parameter;
- (2) Basic setting according (1) and (2) in "Device working self-checking";
- (3) In "Serial Port" setting page, device parameter as below:

- A) Choose RS485 as "Transparent Transmission";
- B) Baud Rate, Data Bit, Parity Bit, Stop Bit setting should be corresponding with items, otherwise communication will be failure. If multi items, all items parameter should corresponding with device;
- C) Click "Save" button.

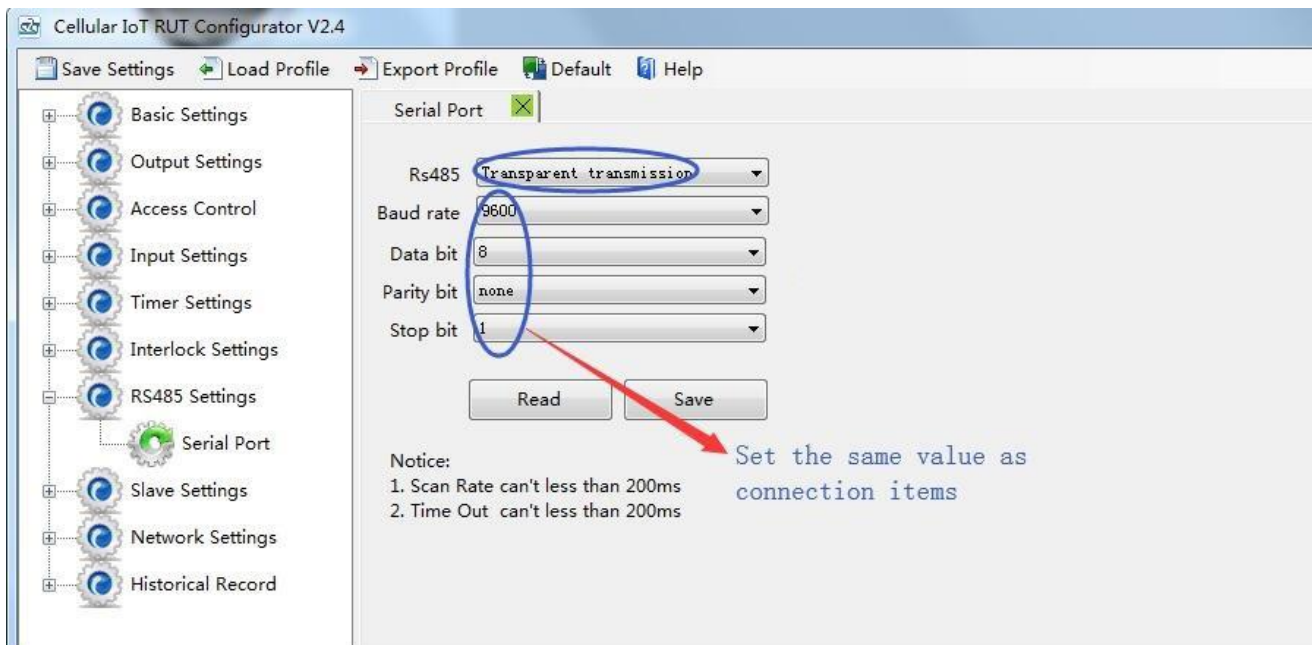

- (4) In "GPRS Setting" page, set "Communication Data" as "Modbus RTU Protocol", then set "Server IP/DNS" and "Port", also can set handshake protocol like "Login Message" below:

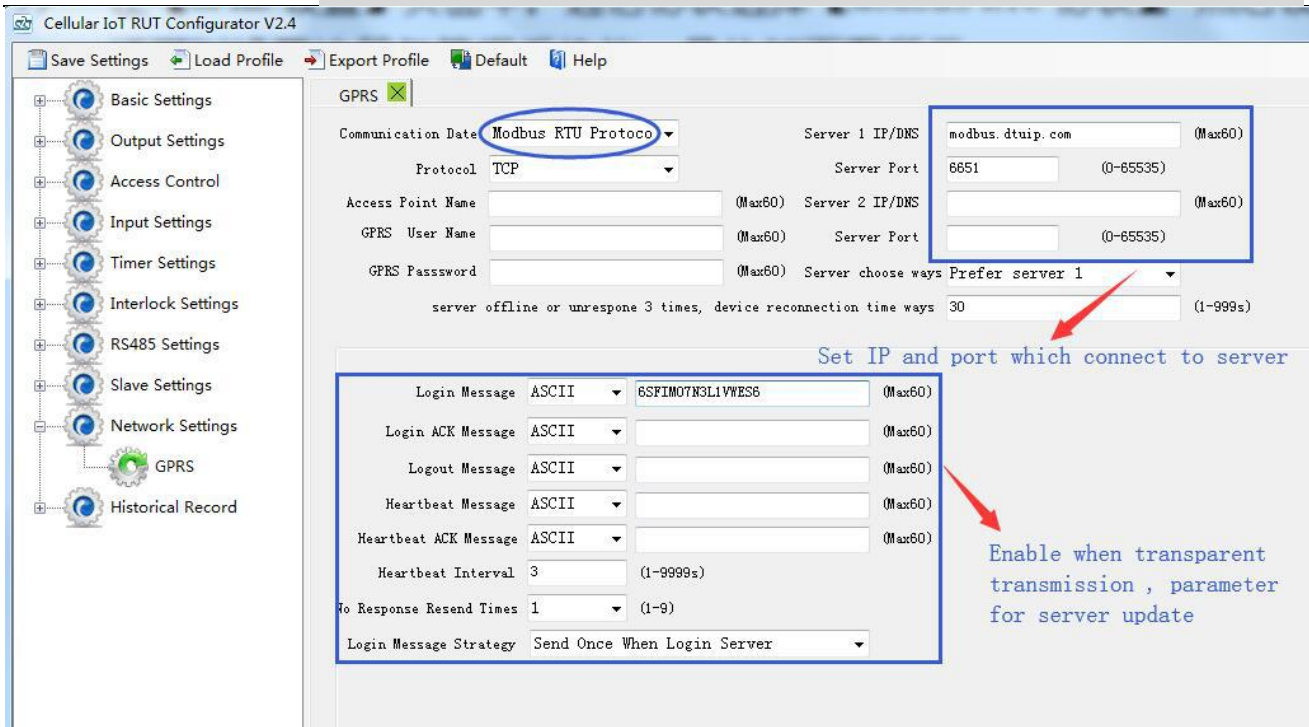

(5) Click "Save Settings" in the menu, then switch device off.

(6) Switch the DIP mode to "Run".

(7) Switch the device on, enter into working mode, device running as transparent transmission when data communication between cloud server and items.

Device connect to www.My-M2M.com cloud configuration,

wechat notify application

Device can connect to cloud and SCADA via GPRS/3G/4G network, also can connect to clients own server and King Pigeon www.My-M2M.com cloud server. King Pigeon [my-m2m.com](http://www.My-M2M.com) cloud as sample below:

King Pigeon my m2m cloud support Modbus TCP, cloud configuration, wechat alarm function, welcomed editable function.

(1) Basic setting according (1) and (2) in "Device working self-checking";

(2) In "Basic Parameter" setting page, set device ID, range 1~247 in Modbus RTU protocol as below:

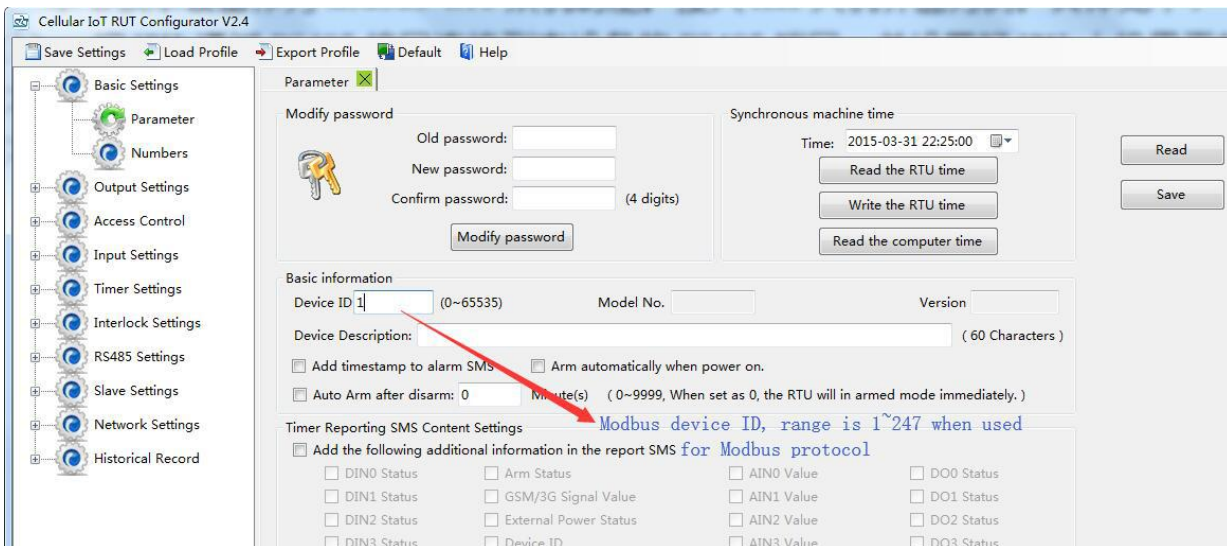

(3) In "GPRS" setting page, set parameter as below:

When Communication Data as "Modbus RTU Protocol", then server IP/DNS should be: modbus.dtuip.com, port is 6651, pls contact King Pigeon Sales for "Login Message Writing";

When Communication Data as "Modbus TCP Protocol", then server IP/DNS should be: modbus.dtuip.com, port is 6655, pls contact King Pigeon Sales for "Login Message Writing";

When Communication Data as "King Pigeon RTU/Definition Protocol", then server IP/DNS should be: rtu-m2m.com , port is 8001, pls provide device IMEI to King Pigeon Sales (Only used for S272).

Default: Sever 1 IP/DNS: modbusrtu.kpirtu.com

Server Prot:4000

Login Message: IMEI code adds zero

Use the default settings to connect directly to the Kingpigeon 3.0 platform

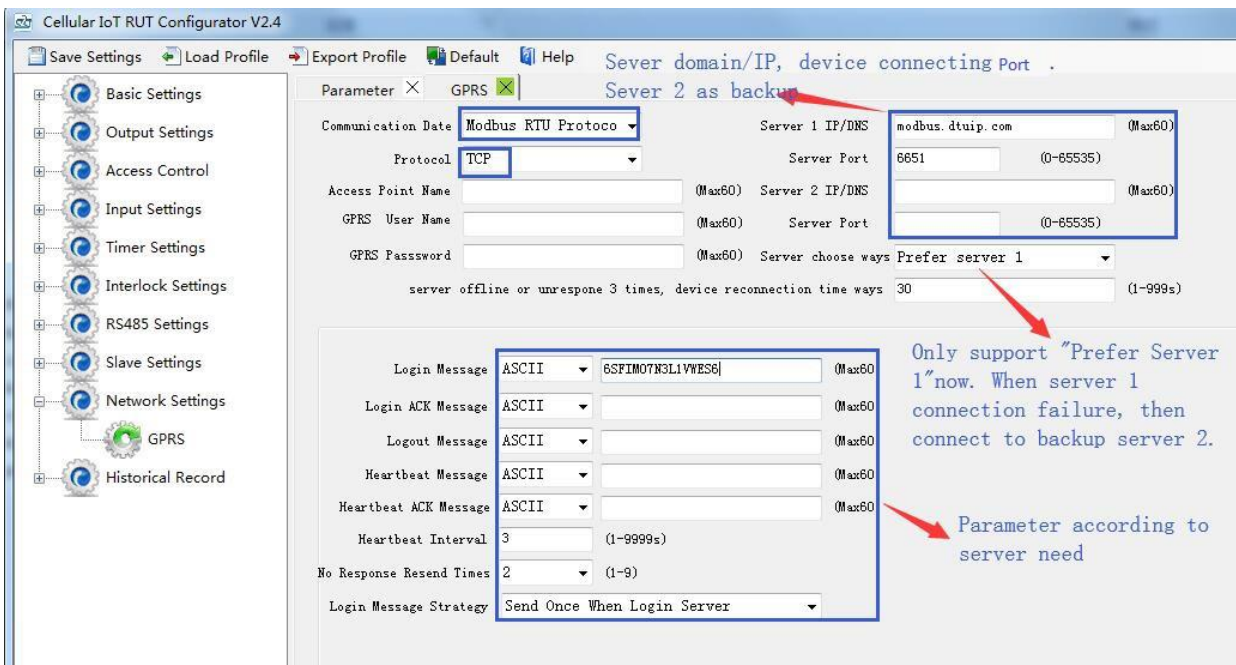

Use the default settings to connect directly to the Kingpigeon 3.0

(4) Click "Save Settings" in the menu, then switch device off.

(5) Switch the DIP mode to "Run".

(6) Switch the device on, enter into working mode, then device I/O can connect to network.

8. Device SMS Command and SMS APP

The user can send SMS commands to setup or operate the device, also can use the APP to control it easier. The APP is under SMS communication, but their makes the program and operation easier than edit SMS every time.

The Android APP search "M2M RTU" or click to download link:

<http://nc-apk.wdicdn.com/9/c8/1fd8e70a8634e9b4763a6a7114888c89.apk>

The IOS APP search "M2M RTU" or click to download link (IOS 7.0 version or above support):

<https://itunes.apple.com/us/app/gsm-3g-m2m-rtu/id1095288504?l=zh&ls=1&mt=8>

Or can scan QR code below:

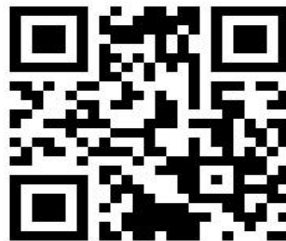

SMS APP interface as below:

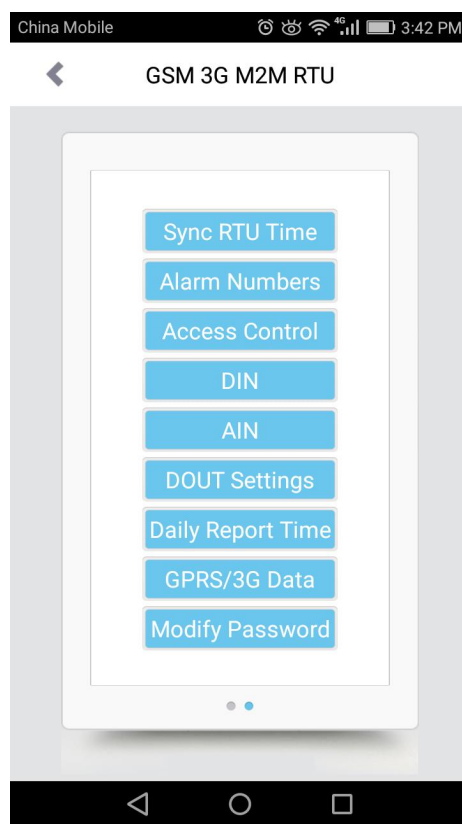
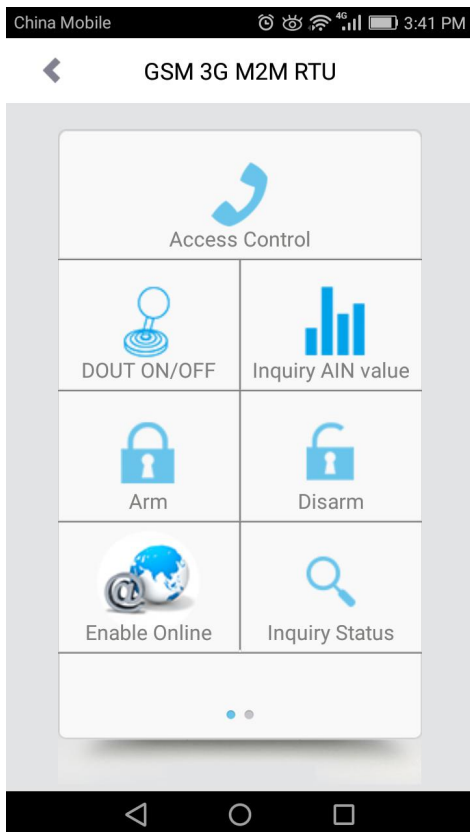

SMS Command List:

The SMS commands will be used for remote control the RTU are below:

1) Commands error return SMS



Event	Return SMS Content
Any incorrect Command	SMS Format Error, Please check Caps Lock in Command!

2) External DC Status

Event	Return SMS Content
External DC goes off	External DC Power Goes OFF
External DC Power Goes ON	External DC Power Goes ON

3) Modify Password, 4digits, default is 1234

SMS Command	Return SMS Content
Old Password+P+New Password	This is the New Password, please remember it carefully.

4) Arm/Disarm SMS Command

SMS Command	Return SMS Content	
Arm	password+AA	Armed
Disarm	password+BB	Disarmed

5) Set RTU time, format is 2015-05-22 15:20:30W01, the W01 stands for Monday, W07 stands for Sunday.

SMS Command	Return SMS Content
password+Dxxxx-xx-xxTxx: xx: xxWxx	xxxx(Y)XX(M)XX(D)xx(H)X(M)xx(W)

6) Inquiry Current Status SMS Command

SMS Command	Return SMS Content
password+EE	Armed/Disarmed Model: Version: IMEI: GSM Signal Value: External DC Power Goes OFF/ON

7) Setup 10 User number (Alarm Number&Access Control Number), max 21digits. (Return 0~4 or 5~9 separately while setting.)

SMS Command	Return SMS Content	
Setup	password+A+series number+T+tel number Notice: Series number = 0~9	Tel1: --- Tel2: --- Tel3: 13570810254 Tel4: --- Tel5: ---
Inquiry	password+A	Return all numbers
Delete	password+A+series number	Return 0~4 or 5~9 numbers.

8) Authority User Number to access control: authorized number can dial to disarm and open the door.

SMS Command	Return SMS Content	
Setup	Specified access control time: password+B+series number+S+start time+E+endtime Always can access control: password+B+series number+P Notice: Time format is 201505231230, stands for year, month, date, hour, minute.	Tel1: --- Tel2: --- Tel3: 13570810254 Tel4: --- Tel5: ---
Inquiry	password+B	Return all authorized user numbers
Delete	password+B+series number	Return all authorized user numbers

9) Setup Daily Report time



SMS Command		Return SMS Content
Setup	password+DR+series number+T+time Notice: Series number =0~9, e.g.: 1234DR1T12:30	Daily SMS Report at: xx:xx
Inquiry	password+DR	
Delete	password+DRDEL	

10) Inquiry DIN Status

SMS Command		Return SMS Content
Inquiry Status	password+DINE	DIN1:Open/Close DIN2: Open/Close -----

11) Setup AIN Name

SMS Command		Return SMS Content
Set Threshold	password+AINR+channel number+Lxxx+Hxxx	AINx: Low:xxx,High:xxx.
Inquiry Threshold	password+AINR+ channel number<nnnnnnnn>	AINx: Low:xxx, High:xxx. AINy: Low:xxx, High:xxx.
Delete Threshold	password+AINR+ channel number+DEL	
Set AIN measurement range	password+AINM+ channel number+Lxxx+Hxxx	AINx: Min:xxx,Max:xxx
Inquiry measurement range	password+AINM+ channel number<nnnnnnnn>	AINx: Min:xxx, Max:xxx. AINy: Min:xxx, Max:xxx.
Delete measurement range	password+AINM+channel number+DEL	
Inquiry AIN Current Value	password+AINE+channel number<nnnnnnnn>	AINx: xxxx ,+【Normal/Higher/Lower】
Inquiry All AIN Current Value	password+AINE	AIN0: xxxx ,+【Normal/Higher/Lower】 AIN1: xxxx ,+【Normal/Higher/Lower】 ----

12) SMS Control Digital Output

SMS Command		Return SMS Content
Set DO Name	password+DO+channel number+T	DOx:xxxx
Inquiry DO Name	password+DO+ channel number<nnnn>	
Delete DO Name	password+DO+ channel number+DEL	
Switch ON(Close)	password+DOC+ channel number<nnnn> , can close multi channel, till next event trigger or SMS command.	DOx: ON DOy:ON
Switch OFF(Open)	password+DOO+ channel number<nnnn>	DOx: OFF DOy:OFF
Inquiry DO Current Status	password+DOE+ channel number<nnnn>	DOx: ON/OFF DOy:ON/OFF
Inquiry all DO Current Status	password+DOE	DO1: ON/OFF DO2:ON/OFF ---
Time Switch ON (Close)	password+DOLC+ channel number<nnnn> , can close multi channel, till time setting in configurator software finished.	
Set Pulse Output time	password+DOT+xxx (3 digital, unit is seconds)	Pulse Output Time:xxxS



Inquiry pulse output time	password+DOT	Pulse Output Time:xxxS
Pulse Ouput	password+DOP+channel number<nnnn>	No SMS Return

13) Set Server Parameter (Can not setup DNS by SMS)

SMS Command		Return SMS Content
Set Server IP	password+IP+ IPaddress+P+Com port	Server: Port:
Inquiry	password+IP	
Delete	password+IPDEL	

14) Set GPRS APN/USER NAME/PASSWORD

SMS Command		Return SMS Content
Set	password+AP+apn+#+username+#+userpassword	APN: User Name: Password:
Inquiry	password+AP	
Delete	password+APDEL	

15) GPRS Online

SMS Command	Return SMS Content
password+GPRSONLINE	GPRS always online

16) Delete Historical Data

SMS Command	Return SMS Content
password+HISDEL	Delete all historical records

17) Clear/Inquiry Pulse Counter Value

SMS Command		Return SMS Content
Clear Pulse Counter Value	password+DINOCLR	Clear Successfully
Inquiry Pulse Counter Value	password+PR	Counter Current Value: XX

9. Device GPRS/3G/4G Communication Protocol

Device can connect to Cloud and SCADA via GPRS/3G/4G network, support Transparent Transmission, Modbus RTU over TCP, Modbus TCP and King Pigeon RTU protocol. User also can connect device to third party cloud or server.

Device Networks Topology:

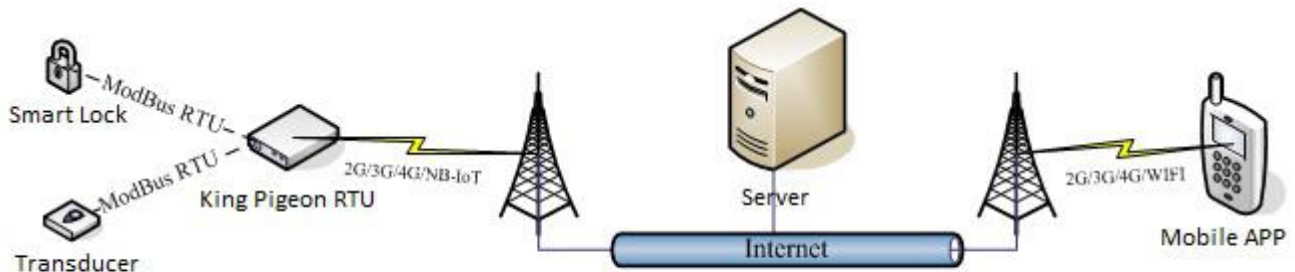

Communication Networks:

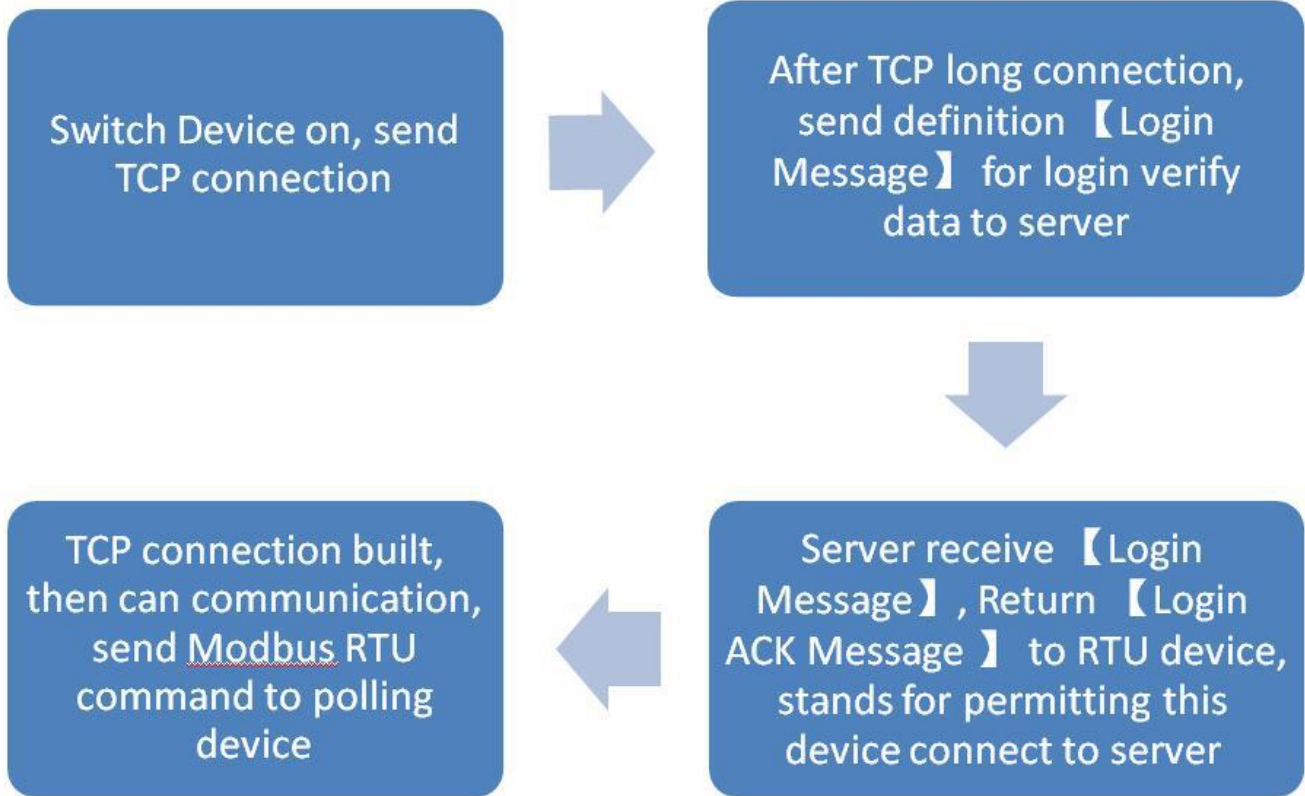

 Message communication sequence:

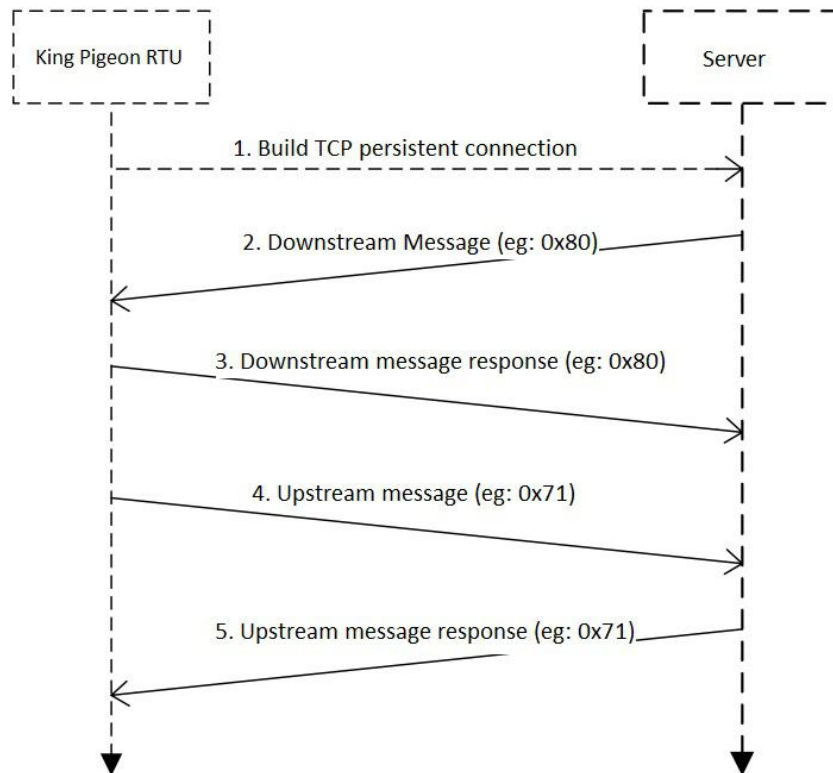

 Transparent Transmission

Pls refer to "Transparent Transmission" content above.

King Pigeon IoT RTU Protocol/ Definition Protocol

If users need device send alarm data, or timely send data to server, can choose this communication protocol. Set "Communication Data" in "GPRS" setting page, need to choose "King Pigeon RTU/Definition protocol", "Protocol" choose TCP, set the Domain/IP/Port of connecting server, other parameter setting according to server.

Notice:

- 1) When Modbus TCP or Modbus RTU over TCP communication protocol adopted, device used as Internet remote server or slave device of cloud. So device ID is necessary for server polling device address data, and Internet remote server and cloud used for Modbus Master function.
- 2) When Modbus TCP or Modbus RTU over TCP communication protocol adopted, cloud server can remotely read and write device register address, according to Modbus TCP or Modbus RTU protocol. Device register address and function code refer to "RS485 Serial Port Setting---->Modbus RTU Slave Function---->Device I/O Register Address and Function Code".

Modbus TCP Protocol

Device can connect to server or cloud to build TCP connection automatically via GPRS/3G/4G networks. After building TCP connection, server or SCADA or cloud can send Modbus TCP command to device for Modbus TCP communication.

Modbus RTU Over TCP

After device switched on, automatically connect to server or cloud to build TCP connection via GPRS/3G/4G networks. Users can set handshake protocol, login message, heartbeat or other parameter according to cloud server. After TCP connection, server or SCADA or cloud can send Modbus RTU command to device, to build Modbus RTU networks which based on TCP connection.

For Modbus RTU over TCP protocol, setting as below:

- (1) In "Basic Parameter" setting, set device ID, range 1~247 in Modbus RTU protocol, click "Save" as below:

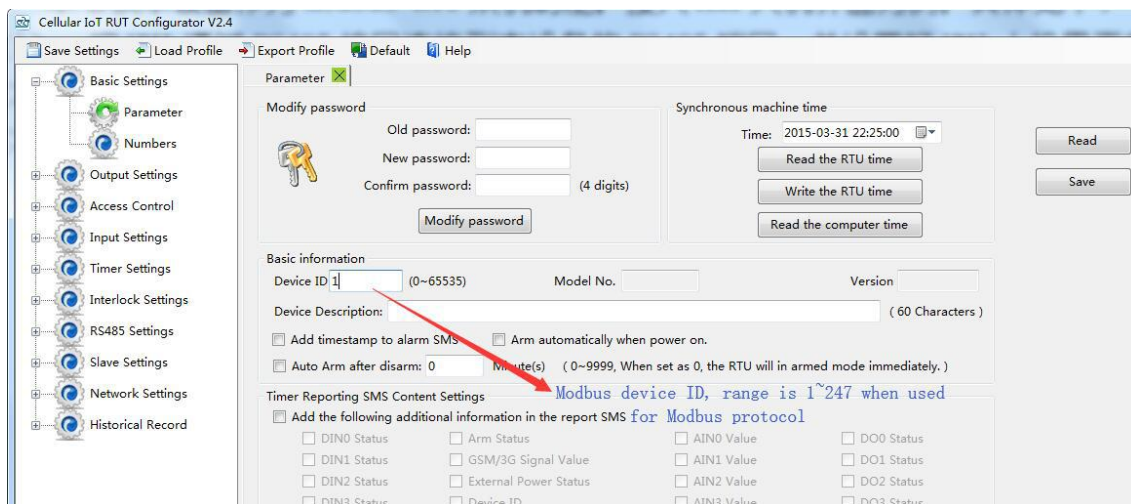

- (1) In "GPRS" setting page, "Communication Data" choose "Modbus RTU Protocol", means communication with Modbus RTU over TCP. After setting server IP/DNS and other parameter, click "Save" button as below:

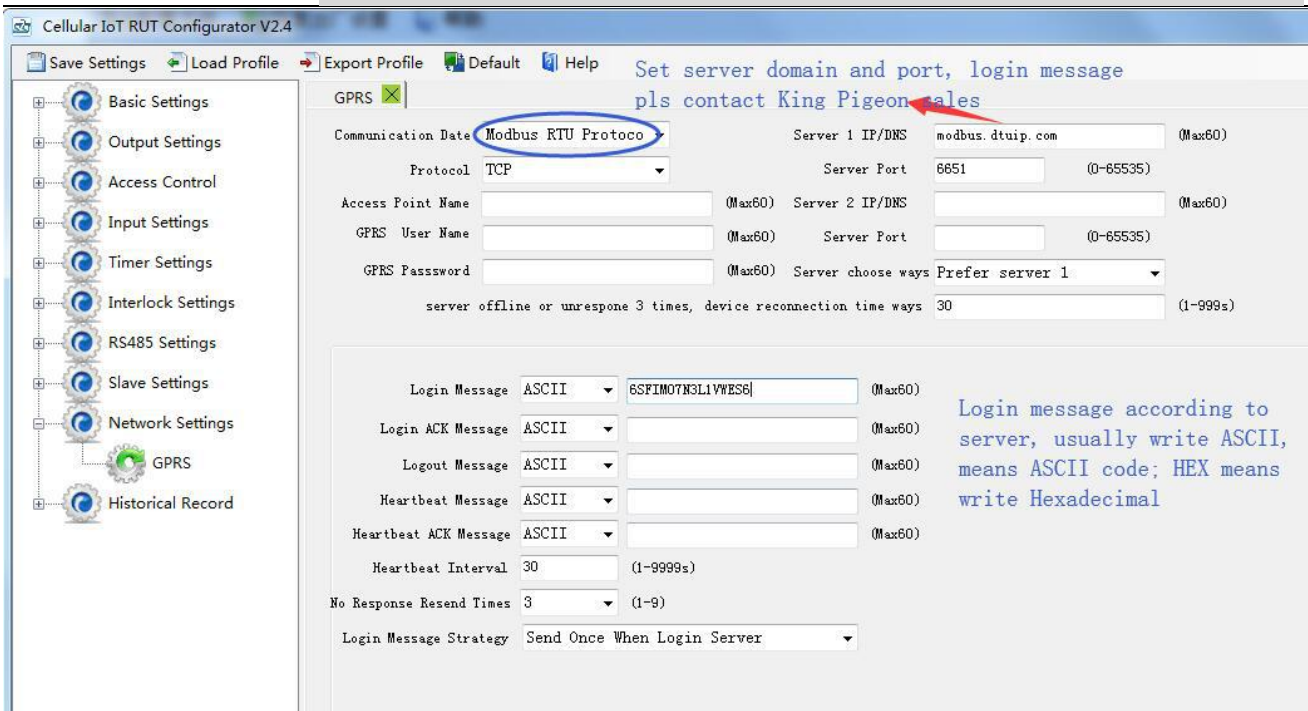

- (4) Click "Save Settings" in the menu, then switch device off.
- (5) Switch the DIP mode to "Run".
- (6) Switch the device on, enter into working mode, then device I/O can connect to network via Modbus RTU protocol.

Modbus RTU over TCP Communication Application

Modbus RTU over TCP communication protocol application, server as Modbus (RTU) Master, device as Modbus (RTU) slave. If device ID is 1, and already connected to remote cloud server via GPRS/3G/4G networks.

Read device relay DO status:

Device's relay DO register address as holding coil, address 0~3, refer to "Device I/O Register Address and Function Code".

Master Send Data Format:

Content	Bytes	Data (H: HEX)	Description
Device Address	1	01H	01H Device, Range: 1-247, according to setting address
Function Code	1	01H	Read holding coil type, function code 01
DO Origin Register Address	2	00 00H	Range: 0000-0003, address refer to "Device I/O Register Address and Function Code"
Read DO Register Qty	2	00 04H	Range: 0001H-0004H, Read DO qty
16CRC Verify	2	3D C9	CRC0 CRC1 low byte in front, high byte in behind

Receiver Return Data Format:

Content	Bytes	Data	Description
---------	-------	------	-------------



		(H: HEX)													
Device Address	1	01H	01H Device, according to the data Master send												
Function Code	1	01H	Read holding coil												
Return Byte Length	1	01H	Return Data Length												
Returning Data	1	02H	02H means 4 DO status, high 4 byte invalid, low 4 Byte 2 converter Binary as below												
			<table border="1"> <thead> <tr> <th>DO3(bit3)</th> <th>DO2 (bit2)</th> <th>DO1 (bit1)</th> <th>DO1 (bit0)</th> </tr> </thead> <tbody> <tr> <td>0</td> <td>0</td> <td>1</td> <td>0</td> </tr> <tr> <td>Open</td> <td>Open</td> <td>Close</td> <td>Open</td> </tr> </tbody> </table>	DO3(bit3)	DO2 (bit2)	DO1 (bit1)	DO1 (bit0)	0	0	1	0	Open	Open	Close	Open
			DO3(bit3)	DO2 (bit2)	DO1 (bit1)	DO1 (bit0)									
			0	0	1	0									
Open	Open	Close	Open												
Device current relay status: DO0,DO2,DO3 = Open, DO1= Close															
16CRC Verify	2	D0 49H	CRC0 CRC1 low byte in front, high behind												

Example: Read 4 relays DO0~DO3 status, device address as 1 :

Server send: 01 01 00 00 00 04 3D C9

01H= Device address; 01H= Read relay function code; 00 00H= Read starting relay DO0 address; 00 04H= Read serial 4 DO status; 3D C9H CRC= Verify.

Device answer: 01 01 01 02 D0 49

01H= Device address; 01H= Read relay function code; 01H= Return data byte qty; 02H= Returning data, stands for Binary 0000 0010 high 4 byte invalid, low 4 byte 0010, sort as DO3 DO2 DO1 DO0 status, D0 49HCRC verify. If read DO or multi DO status, only need to revise " DO Origin Register Address " and " Read DO Register Qty ", calculate the CRC again, returning data according to description data.

Control device DO output:

1) Control 1 channel device DO output

Master Send Data Format:

Content	Bytes	Data (H: HEX)	Description
Device Address	1	01H	01H Device, Range: 1-247, according to setting address
Function Code	1	05H	Write single holding coil type, function code 05
DO Register Address	2	00 00H	Range: 0000-0003, stands for DO0-DO3
Active	2	FF 00H	This value: FF 00H or 00 00H, FF 00H= Close relay, 00 00H= Open relay
16CRC Verify	2	8C 3AH	CRC0 CRC1 low byte in front, high behind

Receiver Return Data Format:

Content	Bytes	Data	Description
---------	-------	------	-------------



		(H: HEX)	
Device Address	1	01H	01H Device, according to the data Master send
Function Code	1	05H	Write single holding coil type, function code 05
DO Register Address	2	00 00H	Range: 0000-0003, stands for DO0-DO3
Active	2	FF 00H	This value: FF 00H or 00 00H, FF 00H= Already activated close relay, 00 00H= Already activated open relay
16CRC Verify	2	8C 3AH	CRC0 CRC1 low byte in front, high behind

Example: Control relay DO0 close, then:

Server send: 01 05 00 00 FF 00 8C 3A

01H= Device address; 05H= Control single relay command; 00 00 H DO0= Address; FF 00H= DO0 close; 8C 3A H16 byte CRC verify.

Device answer: 01 05 00 00 FF 00 8C 3A

01H= Device address; 05H= Control single relay command; 00 00 H DO0= Address; FF 00H= Active DO0 close; 8C 3AH 16 byte CRC verify.

If single control other relay outputs, only need to change "DO Register Address" and "Active", calculate CRC verify again.

2) Multi control DO outputs

Master Send Data Format:

Content	Bytes	Data (H: HEX)	Description												
Device Address	1	01H	01H Device, according to setting address												
Function Code	1	0FH	Write multi holding coil												
DO Starting Register Address	2	00 00H	Range: 0000-0003, stands for DO0-DO3												
Control Relay Qty	2	00 04H	Qty: 0-4												
Write Byte Qty	1	01H	Write 1 byte, since device only 4DO, use 4 binary can do it												
Writing Data	1	0FH	0FH stands for 4 DO status, high 4 byte invalid, low 4 byte F converter to binary as below <table border="1" style="margin: 5px auto;"> <tr> <td>DO3(bit3)</td> <td>DO2 (bit2)</td> <td>DO1 (bit1)</td> <td>DO1 (bit0)</td> </tr> <tr> <td>1</td> <td>1</td> <td>1</td> <td>1</td> </tr> <tr> <td>Active close</td> <td>Active close</td> <td>Active close</td> <td>Active close</td> </tr> </table> <p>1= Active close, 0= Active open</p>	DO3(bit3)	DO2 (bit2)	DO1 (bit1)	DO1 (bit0)	1	1	1	1	Active close	Active close	Active close	Active close
DO3(bit3)	DO2 (bit2)	DO1 (bit1)	DO1 (bit0)												
1	1	1	1												
Active close	Active close	Active close	Active close												
16CRC Verify	2	7E 92H	CRC0 CRC1 low byte in front, high behind												

Receiver Return Data Format:

Content	Bytes	Data	Description
---------	-------	------	-------------



		(H: HEX)	
Device Address	1	01H	01H Device, according to setting address
Function Code	1	0FH	Write multi holding coil
DO Register Address	2	00 00H	Range: 0000-0003, stands for DO0-DO3
Active Relay Qty	2	00 04H	Qty: 0-4, stands for how many relays already actived
16CRC Verify	2	54 08H	CRC0 CRC1 low byte in front, high behind

Example: Close device 4 DO at same time, then:

Server send: 01 0F 00 00 00 04 01 0F 7E 92

01H= Device address; 0FH= Control multi relay; 00 00H= Relay DO0 starting address; 00 04H= Control 4 relays; 01H= Send data qty; 0FH= Data sent converter to binary 0000 1111 high 4 byte invalid, low 4 byte 1111 sort to match DO3 DO2 DO1 DO0, 1 stands for close relay, 7E 92H CRC verify.

Device answer: 01 0F 00 00 00 04 54 08

01H= Device address; 0FH= Control multi relay; 00 00H= Relay DO0 starting address; 00 04H= Actived 4 relays; 54 08H CRC verify.

If need to control multi relays at same time, only need to change "Relay Starting Address", "Control Relay Qty", "Write Data" and calculate "CRC Verify" again.

Read device DIN status:

Master Send Data Format:

Content	Bytes	Data (H: HEX)	Description
Device Address	1	01H	01H Device, Range: 1-247, according to setting address
Function Code	1	02H	02 read input coil DIN status
DIN Register Address	2	00 00H	Range: 0000-0007, stands for DIN0-DIN7
Read DIN Register Qty	2	00 08H	Read qty of DIN status
16CRC Verify	2	79 CCH	CRC0 CRC1 low byte in front, high behind

Receiver Return Data Format:

Content	Bytes	Data (H: HEX)	Description
Device Address	1	01H	01H Device, Range: 1-247, according to setting address
Function Code	1	02H	02 read input coil DIN status
Return Bytes Qty	1	01H	Range: 0000-0007, stands for DIN0-DIN7



Returning Data	1	FFH	FFH converter to binary 1111 1111 from high to low byte, stands for DIN7-DIN0 status							
			DIN7 (bit7)	DIN6 (bit6)	DIN5 (bit5)	DIN4 (bit4)	DIN3 (bit3)	DIN2 (bit2)	DIN1 (bit1)	DIN0 (bit0)
			1	1	1	1	1	1	1	1
			Close	Close	Close	Close	Close	Close	Close	Close
			1= Close, 0= Open							
16CRC Verify	2	E1 C8H	CRC0 CRC1 low byte in front, high behind							

Example: Inquiry device 8 DIN data at same time, then:

Server send: 01 02 00 00 00 08 79 CC

01H= Device address; 02H= Inquiry DIN status; 00 00HDIN= Starting address; 00 08H= Serial reading 8 DIN status; 79 CC H CRC verify.

Device answer: 01 02 01 FF E1 C8

01H= Device address; 02H= Inquiry DIN status; 01H= Returning data bytes qty; FFH DIN status, every byte stands for one DIN status, FFH converter to binary 1111 1111 from high to low byte, stands for DIN7-DIN0 status, 0= Open, 1= Close, E1 C8H 16 byte CRC verify.

If need to inquiry multi DIN status, only need to change "DIN Starting Address", "Reading DIN Register Qty", calculate CRC verify again.

Read device AIN DIN pulse count value, temperature and humidity value, external power voltage value:

Master Send Data Format:

Content	Bytes	Data (H: HEX)	Description
Device Address	1	01H	01H Device, Range: 1-247, according to setting address
Function Code	1	04H	04 read input register
Register Starting Address	2	00 00H	One address can read 2 bytes. AIN address range: 0000-000BH, One AIN data take two address, temperature address: 0018H, humidity address: 0019H, DIN1 count value address: 001A, 001B External power voltage address: 000E。
Read Register Qty	2	00 1CH	Read qty of input register, read AIN0 to DIN0 count value address, total 28 register, 0000H to 0001BH.
16CRC Verify	2	F1 C3H	CRC0 CRC1 low byte in front, high behind

Receiver Return Data Format:

Content	Bytes	Data (H: HEX)	Description
Device Address	1	01H	01H Device, Range: 1-247, according to setting address
Function Code	1	04H	04 read input register



Data Bytes Range	1	38H	One address can read 2 bytes. AIN address range: 0000-000BH, One AIN data take two address, temperature address: 0018H, humidity address: 0019H, DINO count value address: 001A,001B External power voltage address: 000E。																																																
Returning Data	N	00 00 00 E7 00 00 00 DD 00 00 00 DD 00 00 00 DC 00 00 00 DE 00 00 00 DF 00 00 00 00 04 C6 01 9A 00 00 00 01 00 01 00 01 00 01 00 01 00 01 00 01 0B 36 1B E4 00 00 00 0B H	<p>N= Returning bytes, sample data 56 points:</p> <table border="1"> <thead> <tr> <th>AIN</th> <th>AIN0</th> <th>AIN1</th> <th>AIN2</th> <th>AIN3</th> <th>AIN4</th> <th>AIN5</th> </tr> </thead> <tbody> <tr> <td>Receiving Data</td> <td>00 00 00 E7H</td> <td>00 00 00 DDH</td> <td>00 00 00 DDH</td> <td>00 00 00 DCH</td> <td>00 00 00 DEH</td> <td>00 00 00 DFH</td> </tr> <tr> <td>Decimal Value</td> <td>194</td> <td>207</td> <td>0</td> <td>0</td> <td>0</td> <td>0</td> </tr> <tr> <td>Real Value</td> <td>1.94</td> <td>2.07</td> <td>0</td> <td>0</td> <td>0</td> <td>0</td> </tr> </tbody> </table> <table border="1"> <thead> <tr> <th>Other Value</th> <th>External Power Voltage</th> <th>Temperature</th> <th>Humidity</th> <th>DINO Count Value</th> </tr> </thead> <tbody> <tr> <td>Receiving Data</td> <td>04 C6H</td> <td>0B 36H</td> <td>1B E4H</td> <td>00 00 00 0B</td> </tr> <tr> <td>Decimal Value</td> <td>1222</td> <td>2870</td> <td>7140</td> <td>11</td> </tr> <tr> <td>Real Value</td> <td>12.22V</td> <td>28.7℃</td> <td>71.4%RH</td> <td>11 times</td> </tr> </tbody> </table> <p>AIN, External Power Voltage, Temperature, Humidity real value=Register value/100。</p>	AIN	AIN0	AIN1	AIN2	AIN3	AIN4	AIN5	Receiving Data	00 00 00 E7H	00 00 00 DDH	00 00 00 DDH	00 00 00 DCH	00 00 00 DEH	00 00 00 DFH	Decimal Value	194	207	0	0	0	0	Real Value	1.94	2.07	0	0	0	0	Other Value	External Power Voltage	Temperature	Humidity	DINO Count Value	Receiving Data	04 C6H	0B 36H	1B E4H	00 00 00 0B	Decimal Value	1222	2870	7140	11	Real Value	12.22V	28.7℃	71.4%RH	11 times
AIN	AIN0	AIN1	AIN2	AIN3	AIN4	AIN5																																													
Receiving Data	00 00 00 E7H	00 00 00 DDH	00 00 00 DDH	00 00 00 DCH	00 00 00 DEH	00 00 00 DFH																																													
Decimal Value	194	207	0	0	0	0																																													
Real Value	1.94	2.07	0	0	0	0																																													
Other Value	External Power Voltage	Temperature	Humidity	DINO Count Value																																															
Receiving Data	04 C6H	0B 36H	1B E4H	00 00 00 0B																																															
Decimal Value	1222	2870	7140	11																																															
Real Value	12.22V	28.7℃	71.4%RH	11 times																																															
16CRC Verify	2	A9 3CH	CRC0 CRC1 low byte in front, high behind																																																

Example: Inquiry device 28 input type register at same time, start from address 0. Include 6 AIN, one device temperature, humidity, external power voltage, DINO count value, then:

Server send: 01 04 00 00 00 1C F1 C3

01H= Device address; 04H= Read input register value; 00 00H AIN0= Starting address; 00 1CH= Serial reading 28 input register value; F1 C3H CRC verify.

Device answer: 01 04 38 00 00 00 E7 00 00 00 DD 00 00 00 DD 00 00 00 DC 00 00 00 DE 00 00 00 DF 00 00 00 00 04 C6 01 9A 00 00 00 01 00 01 00 01 00 01 00 01 00 01 00 01 00 01 0B 36 1B E4 00 00 00 0B A9 3C

01H= Device address; 04H= Read input register value; 56 bytes data after 38H, 00 00 00 E7H AIN0 value, 00 00 00 0DD AIN1 value, 00 00 00 DDH AIN2 value, 00 00 00 DCH AIN3 value, 00 00 00 DEH AIN4 value, 00 00 00 DFH AIN5 value, 00 00 00 00H invalid value, 04 C6H external power voltage value, 01 9A 00 00 00 01 00 01 00 01 00 01 00 01 00 01 00 01 00 01 0B 36H temperature value, 1B 36H humidity value, 00 00 00 0BH DINO count value, A9 3C CRC verify.

10. Upgrade Firmware

The device supports upgrade firmware via USB port directly. If you required upgrade, please contact us to discuss and modify the firmware according to you requirements, we can provide the upgraded firmware to you to upgrade them.

11. Cellular Module Upgrade

The device adopt modular structure design, when user local Gsm operator upgrade network, no need to replace the whole hardware, only need to replace inbuilt communication module, easily upgrade Gsm to 3G, or 3G to 4G network.

Cellular Module Upgrade

Users can easily upgrade GSM (or 3G) to 3G/4G, NB-IoT or 5G network.

No need to replace whole device again when local network upgrade, only pick Gsm module out, put a 3G/4G module in, then device can support 3G/4G.

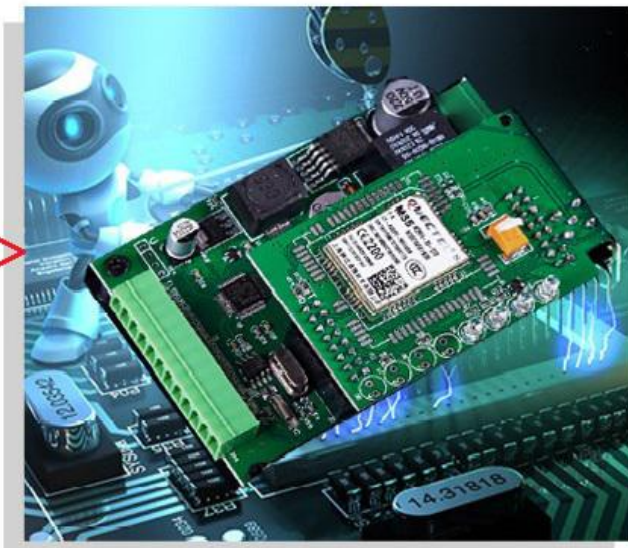

12. Warranty

- 1) This system is warranted to be free of defects in material and workmanship for one year.
- 2) This warranty does not extend to any defect, malfunction or failure caused by abuse or misuse by the Operating Instructions. In no event shall the manufacturer be liable for any alarm system altered by purchasers

The End!

Any questions please help to contact us feel free.

[Http://www.GPRS-M2M.com](http://www.GPRS-M2M.com)