



GSM/3G/4G Gate, Barrier, Shutter,
Garage Door and Door opener
Open gate or garage door with a FREE
call from your mobile phone!
Remote switching machines with a
FREE call from your mobile phone!

GPRS/3G/4G Gate Opener Remote Access Control

KING PIGEON



User Manual

Ver 2.0

RTU5025

(Firmware Version:xPR25B23)

Date Issued: 2020-08-04

All rights reserved by

King Pigeon Comm.Co.,Limited.

www.iot-solution.com

Table of contents

1. Product details	3
1.1 Advantages	3
1.2 Specifications	3
1.3 Dimensions	3
1.4 Standard Packing List and Model Tabel	4
1.5 Applications	4
2. Safety Directions	4
3. Diagram	5
4. Typical Wiring Connection	6
5. Setting by PC software	6
5.1 Basic Settings	6
5.2 Authorized number list management	7
5.3 Historical data	8
6. Setting/Operating by SMS commands	8
6.1 Start	9
6.2 Change password	9
6.3 Authorized number management	10
6.4 Relay control parameters	10
6.5 Digital Input parameters	11
6.6 Self-check auto report/Inquiry status/IMEI code and firmware version	12
6.7 Data function	14
7. Important information	15
8. Maintenance	15
9. Warranty	15
10. Authorized users list paper	16

This handbook has been designed as a guide to the installation and operation of RTU5025 Gate Opener. Statements contained in the handbook are general guidelines only and in no way are designed to supersede the instructions contained with other products.

We recommend that the advice of a registered electrician be sought before any Installation work commences. King Pigeon its employees and distributors, accept no liability for any loss or damage including consequential damage due to reliance on any material contained in this handbook.

King Pigeon its employees and distributors, accept no liability for GSM Network upgrading or SIM Card upgrading due to the technology specifications contained in this handbook.

Caution!

Please read this user manual carefully before install/operate the Gate Opener,

basic electronic acknowledges required.

1. Product details

The RTU5025 is an upgraded version of famous RTU5015 gate opener, a very simple device which can be used for remote control swing or sliding gates and doors or switching devices with authorized access management(**Caller-ID**),well used on door access, gate control, remote switching, or car parking systems. Actually the RTU5025 can be used in places which require to turn ON/OFF your system, machines, equipments remotely with a **FREE phone call** from your mobile or fixed line telephone.

Android APP on Google Play available, PC software for programming via USB, remote server system over TCP/IP supported*,users can easily download the access historical data anywhere anytime.

1.1 Advantages

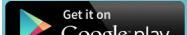
- GSM,3G or 4G band, distribute worldwide applications;
- Up to 3000 authorized phone numbers can be configured at the specified time for access control;
- No call charges. Reject calls from authorized number then carries out the turn ON/OFF action on the first 'ring';
- Secure – Using Caller-ID for verification, unknown phone calls are ignored;
- SMS confirmation of relay actions(door open) to the owner or authorized caller number.
- No need remote control or keys for different users;
- Up to 1,000 events log, download the operation historical data by USB or over GPRS;
- Multiple applications. (gates, bollards, barriers, garage doors, shutters and access doors or machines);
-  Android APP for configuration, search **3G Gate Opener RTU5025** on Google Play to download it.

Digital Inputs

- Two Digital input for motion sensor or other sensors to protect your door and windows, SMS alert to owner immediately when triggered;

Setting

- Android APP, SMS command or PC Software programming;
- Operate from anywhere anytime, no distance limitation;

1.2 Specifications

GSM Frequency	Quad-band 850/900/1800/1900MHz
3G/4G/NB-IoT	Optional: WCDMA/TDD-LTE/FDD-LTE/NB-IoT
Digital Input	2 NC/NO dry contact
Digital Output	1 Relay, 3A/240VAC
Siren Output	12VDC/1A
DC Power supply	9~24VDC/2A
Power consumption	12V input Max. 50mA/Average 25mA
SIM Card	Supporting 3V SIM Card
Antenna	50 Ω SMA Antenna interface
Temperature range	-20~+60 °C
Humidity range	Relative humidity 90%
Backup battery	3.7V/900mAH
Exterior dimension	W88mm*D78mm*H32mm
Net Weight	260 g

1.3 Dimensions

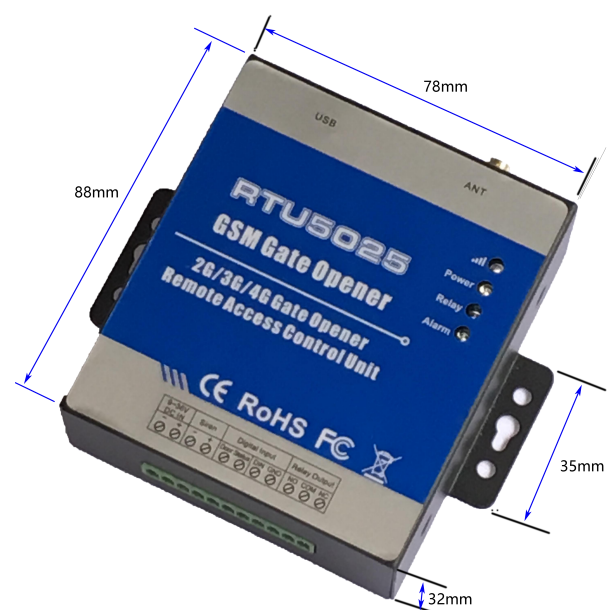

1.4. Standard Packing List

- ✓ Gate Opener * 1
- ✓ Antenna * 1
- ✓ AC/DC Power adaptor *1,
- ✓ User Manual & PC Software CD x1
- ✓ Packing size: 19*14*6 cm
- ✓ Gross Weight: 0.75kg

Optional Accessories:

- ✓ Door contact sensor,
- ✓ Motion detector,
- ✓ Temperature sensor,
- ✓ Infrared Beam Fence,
- ✓ Vibration sensor,
- ✓ Siren. and others.

Order Table:

RTU5025:	GSM 850/900/1800/1900MHz
RTU5025W:	2G: GSM900/1800MHz, 3G WCDMA : 900/2100MHz UMTS ;
RTU5025C:	2G: GSM850/900/1800/1900MHz, 3G: 850/1900MHz UMTS.
RTU5025T:	2G: GSM850/900/1800/1900MHz, 3G: 850/2100MHz UMTS.
RTU5025L:	4G

1.5 Applications:

- Remote open/close swing/sliding gates, doors, shutters, garage doors, locks with a free call!
- Intrusion security alarm, remote ON/OFF motors, lights, pumps, generators, valves and machines.
- **Residential:** Door, gate, garage access control, electronic fan, microwave, air-conditioner control.
- **Industry:** Remote switch equipment, for example: street lights, solar power, motor, inverter, PLC, pumps, fans, etc.
- **Agriculture:** Remote control pumps, etc.
- **Business:** Remote control electronic boxes, bright billboards, LED signs, etc.

2. Safety Directions



Safe Startup

Do not use Gate Opener when using GSM equipment is prohibited or might bring disturbance or danger.



Interference

All wireless equipment might interfere network signals of Gate Opener and influence its performance.



Avoid Use at Gas Station

Do not use Gate Opener at a gas station. Power off Gate Opener when it near fuels or chemicals.



Power it off near Blasting Places

Please follow relevant restrictive regulations. Avoid using the device in blasting places.



Reasonable Use

Please install the product at suitable places as described in the product documentation. Avoid signal shielded by covering the mainframe.



Use Qualified Maintenance Service

Maintenance can be carried out only by qualified maintainer.

3. Diagram



INDICATORS		
Power	ON: AC/DC power supply is ON.	
Alarm	Flash quickly: Alarm occurrence.	
Relay	ON: Relay closed(ON).	
Signal	Flash per 1 second(quickly): registering to cellular network. Flash per 2 seconds: Normal status. OFF: can't connect to SIM card or unregistered to the cellular network	
Connection Terminals		
Power	+	Power supply input, Positive wire(Red).
	-	Power supply input, Negative wire(Black).
Digital Input	Door Status	DIN1,Connect to the door lock's contact points(if have) or door contact sensor, voltage free(dry contact) ports.
	DIN/GND	DIN2,Connect to sensor/detectors, voltage free(dry contact) ports.
Relay Output	NO	Normally Open port
	COM	Common port
	NC	Normally Close port
Siren	+	12V DC + output, connect to siren's Positive wire.
	-	GND, connect to siren's Negative wire.
USB	Connect to PC for configuration and reading the historical data.	
ANT	Connect to GSM/3G antenna.	

4. Typical wiring connection:

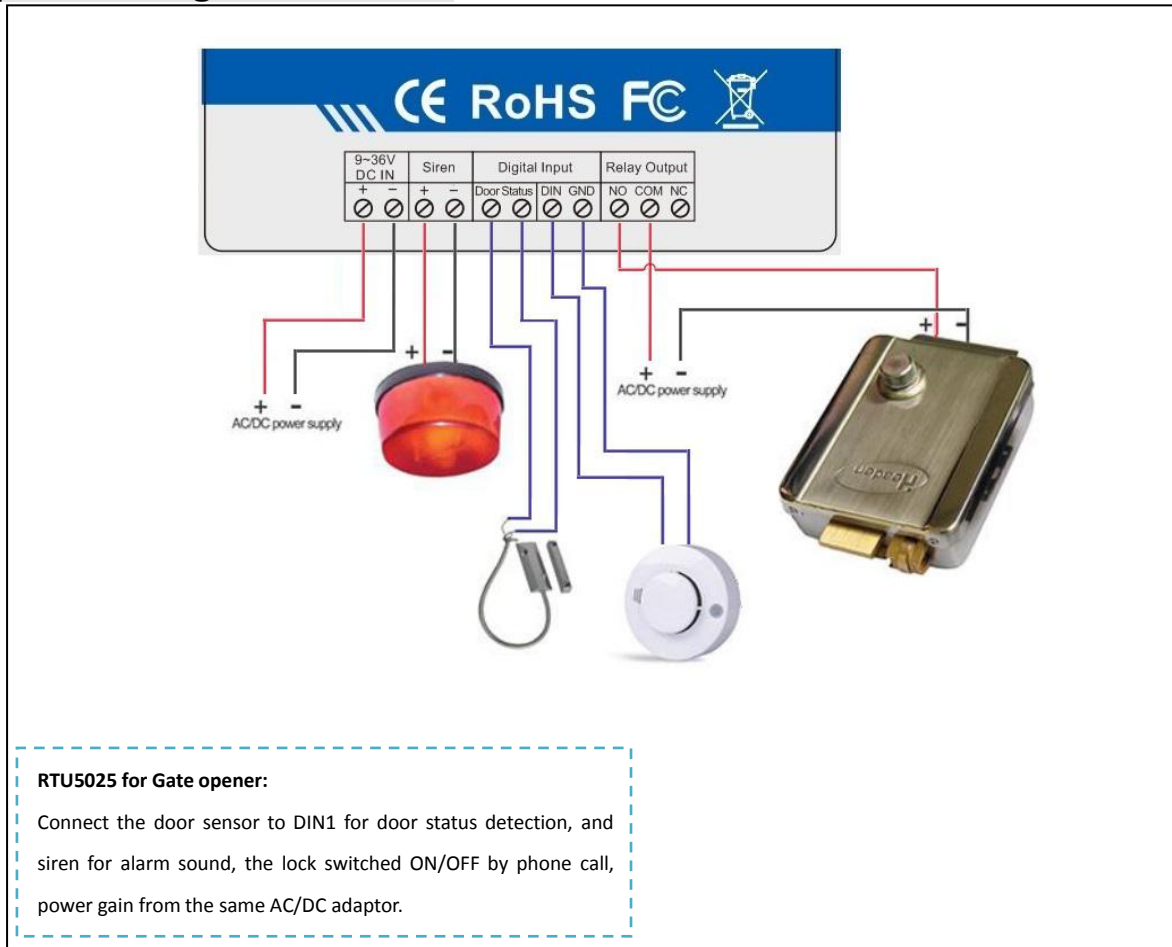

5. Setting by PC software instructions (recommend):

1. Open the unit's back cover and insert the SIM card.
2. Connect the unit's power supply.
3. Send SMS command `pwdTELphone number of the RTU5025#` to set the time. Do not include the "", for example: `1234TEL001911#`, **this step is MUST.**
4. Connect the unit to the computer using the USB cable.
5. On desktop, right click "My computer" >>> "Property" >>> "Hardware" >> "Device Manager".
6. Find "Ports(COM & LPT)", check the port number of "Silicon Labs CP210xUSB to UART Bridge", for example:COM3. ([Click here](#) to know **how to find out the COM Port on your computer**)
7. Run the configuration software, select the COM Port number, for example:COM3.click "Open", if the downside "COM Port" status indicates Green, connection is successful.
8. Click "Log in", default password is 1234. Enter the new password if you had previously changed it.
9. Click "Read Settings". Configure the parameters as per your needs.
10. Click "Save Settings"
11. After finishing the settings, disconnect the USB cable, restart the unit to enter the working status.
12. You can also download the smart phone APP to set the unit.

1) Basic settings

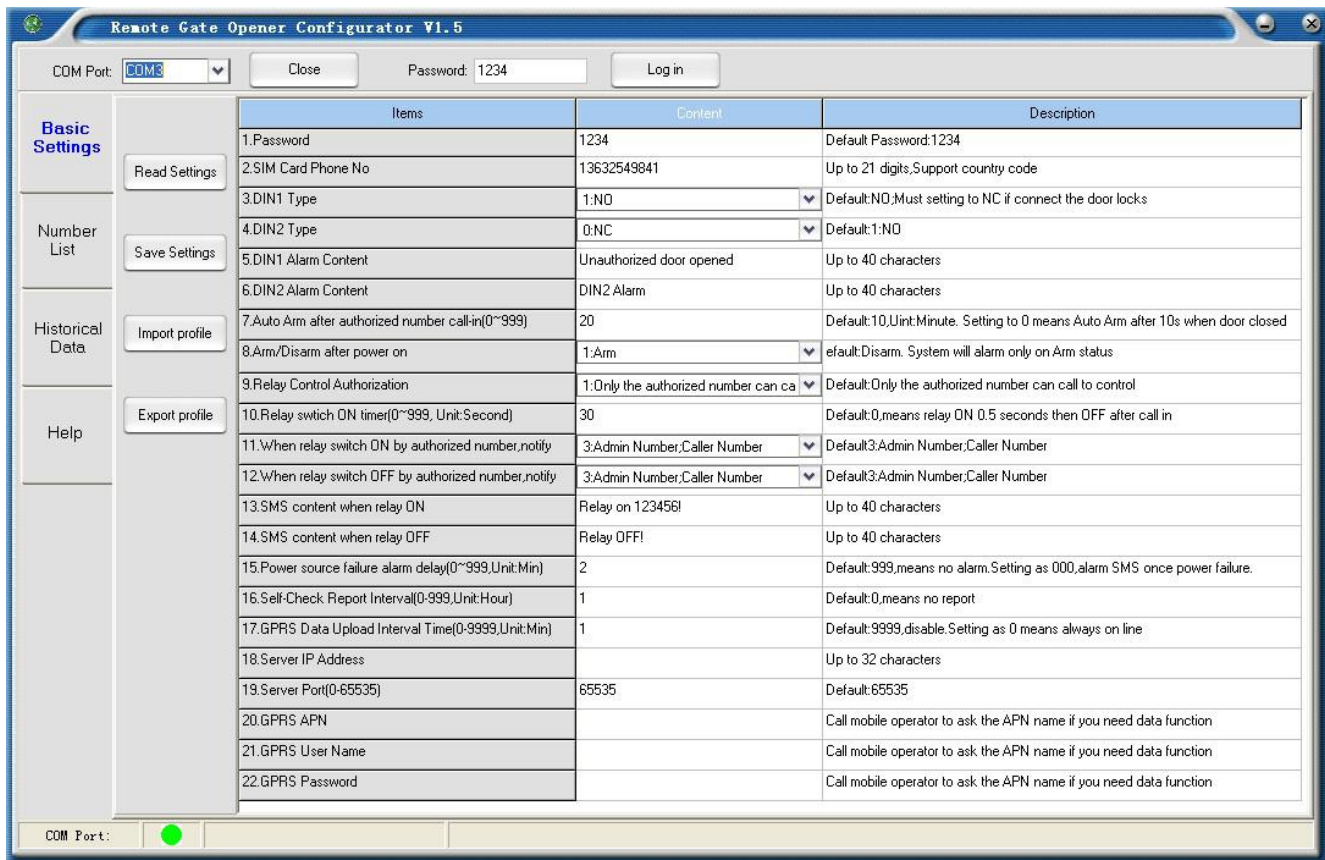

- ✓ **Read Settings:** Read the basic parameter settings from RTU5025 to PC software.
- ✓ **Save Settings:** Save the basic parameter settings to the RTU5025.
- ✓ **Import profile:** Import .xls profile, this can use for a number of RTU5025 with similar settings.
- ✓ **Export profile:** Export the parameter settings as .xls format to the PC, under the /configuration folder.

2) Edit Authorized Number List

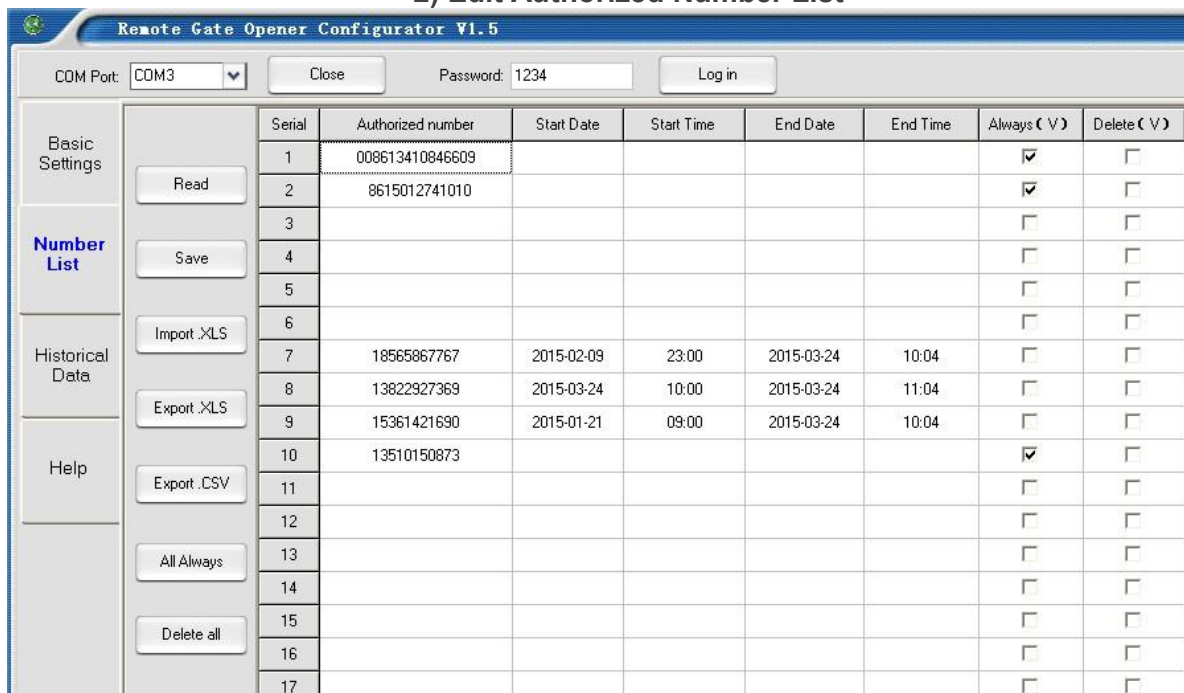

- ✓ If the software shows "ERROR" message when you setting the date & time for the users, please try to change your computer's data & time format to **yyyy-mm-dd** for setting.
- ✓ **Read:** Read the authorized number list from RTU5025 to the PC software.

- ✓ **Save:** Save the authorized number list to RTU5025.
- ✓ **Import .xls:** Import authorized number list (.xls format) profile from PC folder to the software.
- ✓ **Export .xls:** Export the authorized number list (.xls format) to the PC, under the /configuration folder.
- ✓ **Export .csv:** Export the authorized number list (.csv format) to the PC, under the /configuration folder.
- ✓ **All Always:** Select all the numbers as “Always can call in to the RTU5025 for access control”.
- ✓ **Delete all:** Delete all the numbers on the list, after click this button, then click “Save” button, all the numbers on the RTU5025 will be deleted(**Caution to use!**).

3) Historical Data

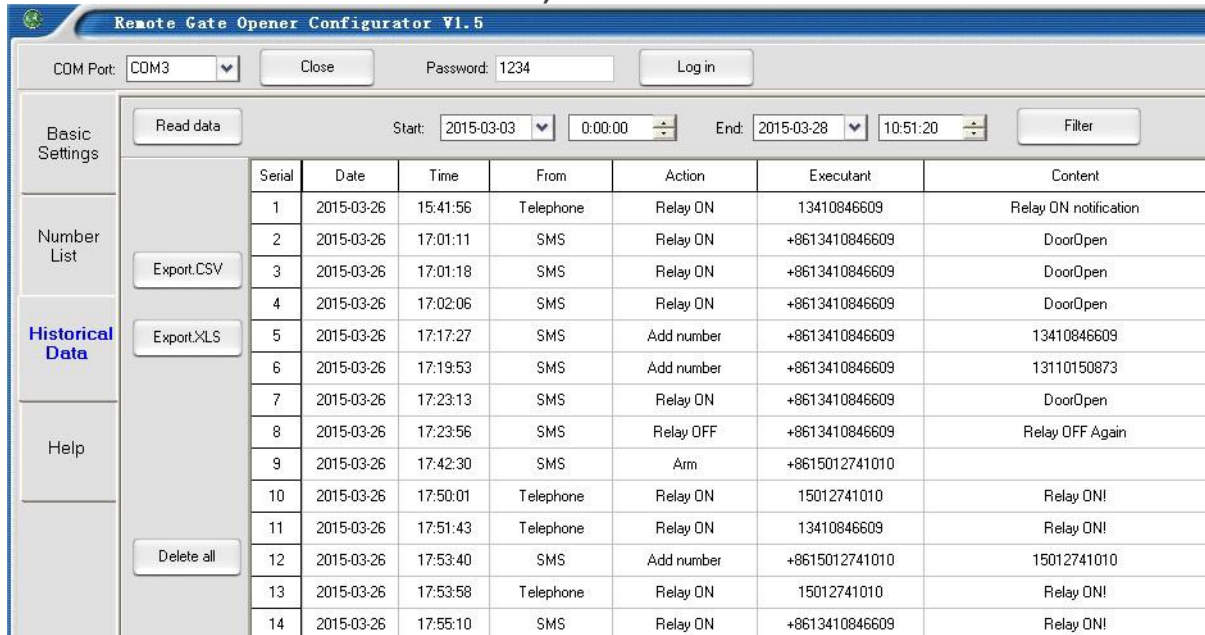

Serial	Date	Time	From	Action	Executant	Content
1	2015-03-26	15:41:56	Telephone	Relay ON	13410846609	Relay ON notification
2	2015-03-26	17:01:11	SMS	Relay ON	+8613410846609	DoorOpen
3	2015-03-26	17:01:18	SMS	Relay ON	+8613410846609	DoorOpen
4	2015-03-26	17:02:06	SMS	Relay ON	+8613410846609	DoorOpen
5	2015-03-26	17:17:27	SMS	Add number	+8613410846609	13410846609
6	2015-03-26	17:19:53	SMS	Add number	+8613410846609	13110150873
7	2015-03-26	17:23:13	SMS	Relay ON	+8613410846609	DoorOpen
8	2015-03-26	17:23:56	SMS	Relay OFF	+8613410846609	Relay OFF Again
9	2015-03-26	17:42:30	SMS	Arm	+8615012741010	
10	2015-03-26	17:50:01	Telephone	Relay ON	15012741010	Relay ON!
11	2015-03-26	17:51:43	Telephone	Relay ON	13410846609	Relay ON!
12	2015-03-26	17:53:40	SMS	Add number	+8615012741010	15012741010
13	2015-03-26	17:53:58	Telephone	Relay ON	15012741010	Relay ON!
14	2015-03-26	17:55:10	SMS	Relay ON	+8613410846609	Relay ON!

- ✓ **Read data:** Read all historical data from RTU5025 to PC software.
- ✓ **Filter:** Filter data from the Start-End time.
- ✓ **Export .xls:** Export the historical data (.xls format) to the PC, under the /configuration folder.
- ✓ **Export .csv:** Export the historical data (.csv format) to the PC, under the /configuration folder.
- ✓ **Delete all:** Click this button will delete/erase all of the historical data on the RTU5025 (**Caution to use!**)

6. Setting by SMS commands(not recommend, for remote setting only)

Notice:

1. The default Password is **1234**.
2. You can program the RTU5025 by APP or SMS commands using your phone. It is safe to do so because in addition to the fact that other people may not know the number of the SIM inserted in it, we also use a Password that makes it impossible for others who doesn't know it, to access the system by chance, and all the action will be recorded.
3.  Search **3G Gate Opener RTU5025** on **Google Play** for download the APP to your Android phone, it will simple and helpful for you to setup the unit.
4. The relay output will change the close or open status by every call in. Means the first time call it, it will close the relay to switch on the lock, if the second call in is in the setting time, then the unit will ignore the setting time, and open the relay, to switch off the lock.
5. Remember that commands must be **CAPITAL LETTERS**. It is AA not aa, EE not Ee etc. Don't add spaces or any other character on the SMS commands.
6. The **pwd** in the command means the password, like 1234 or 5678 if you changed.
7. If the RTU5025 used for gate access only, all you need to do is to change the default password and add the authorized numbers.
8. If you cannot call to control the RTU5025 or cannot send or receive any SMS message from it. please

try to add + in front of the country code or the phone numbers:

For example:

In China, the country code is **0086** The user cell phone number is **13570810254** and has been assigned as the SMS Alert number, the SIM Card number in the panel is **13512345678**.

Problem 1: Alarm but the user hasn't received the SMS Alert.

Solution: Please plus the country code while you setup the 13570810254 as SMS Alert number, means setup **008613570810254** instead of the **13570810254**.

Problem 2: The user number can receive the SMS Alert message from alarm panel, but the alarm panel can not receive the commands from the user number.

Solution: Please add country code to the SIM Card number in the alarm panel. Means send SMS commands to **008613512345678** instead of **13512345678**.

Solution 3: Use mobile phone A to call mobile phone B, the number displayed on B is which you should set as the dial number; Use mobile phone A send SMS to mobile phone B, the number displayed on B is which you should set as the SMS alert number; sometimes you may need to use the 00 to replace the + or use the + to replace the 00 on front of the country code.

9. Export the Authorized number list to .xls/.csv file and keep it for reference in further.
10. For security purpose, the RTU5025 will not return any SMS if command error, so please make sure and check the SMS Commands, or add the country code before the phone number or check the input is in ENGLISH INPUT METHOD and CAPS LOCK.
11. The SMS commands that you will certainly use in the RTU5025 are the following:

6.1 Start (this step is MUST):

Send **pwdTELphone number of the RTU5025#** to the RTU5025 for adjust the time.

E.g.: **1234TEL00861351015#** "00861351015" is the SIM card number which inside of the RTU5025.

Return: Set Success!

Notice:

If the RTU5025 cannot working well in the exactly time, then send the SMS command to adjust time manually as below:

Send **pwd Tcurrent time** to the RTU5025 for adjust the time manually.

E.g.: **1234T1601131300**

T:Command Code.

Current Time: yy(year)mm(month)dd(day)hh(hour)mm(minute).

Return: Set Time OK!

6.2 Change Password

1234Pnew password

RTU5025 Reply: "Password changed to "new password", please remember it carefully. "if successfully.

E.g.: **1234P6666** for change the new password to 6666.

6.3 Authorized User Management

6.3.1 Add authorized user phone number:

`pwdAserial number#authorized number#start time#end time#`

A:command code.

serial number: the authorized number's position, from 0001-3000.

authorized number: the user's phone number, country code may needed.

start time: yy(year)mm(month)dd(day)hh(hour)mm(minute).the start time of this number can call in to control.

end time: yy(year)mm(month)dd(day)hh(hour)mm(minute).the end time of this number can call in to control.

Without start time and end time means: Always can call in to control.

E.g.: **1234A0003#123456#** to set the phone no.123456 at the 3rd position and always can call in to control.

E.g.: **1234A0016#123456#1502050800#1502051000#** to set the phone number 123456 at the 16th position, this number can call in to control during Feb 5th 8:00a.m.(1502050800) to Feb 5th 10:00a.m.(1502051000).

- Note:**
1. The authorized number means the authorized users' phone number.
 2. The Serial Number is the position to store the authorized users, from 0001~3000.
 3. The 1st ~6th position user should be Mobile phone number because of the alarm message will send to these 6 users, and the power failure alarm SMS send to the 1st user only.

6.3.2 Inquiry the Authorized user's position(serial):

`pwdAserial number#`

E.g.: **1234A0002#** to check the number on the 2nd position(serial number2).

6.3.3 Inquiry batch users number

`pwdAL serial number start # serial number end #`

E.g.: **1234AL0002#0050#** to inquiry the 2nd to the 50th users,RTU5025 return several SMS with the numbers list(10 numbers on each SMS).

6.3.4 Delete the Authorized User's Number(or you can overwrite this position with another number).

`pwdA serial number ##`

E.g.: **1234A0002##** to delete the 2nd authorized number.

6.4 Relay Control setting

6.4.1 Allow all numbers can call in to control:

`pwdALL#`

6.4.2 Allow only the authorized numbers can call in to control(Caller-ID for security, default):

`pwdAUT#`

6.4.3 How long time the relay keep close(ON) after phone call in (unit: second)

`pwdGOT close time #`

close time=000~999. Unit: Second

close time=000: relay close 0.5 second then open (use the relay as Latch).

close time=999: relay will always keep close(ON) after call in until the next call in.

Eg: **1234GOT030#** to set relay close 30 seconds(ON) and then open(OFF) after call in.

6.4.4 Who will receive the confirmation SMS when the relay is ON/OFF

`pwdGONab#content#`

for relay ON,

`pwdGOFFab#content#`

for relay OFF.

ab: the ID code of the 1st number(a) and the caller number(b), =0 means disable, =1 means enable.

content: confirmation SMS content.

ID code		RTU5025 send notify SMS to	
a	b	The 1 st number	Caller number
0	0		
0	1		✓
1	0	✓	
1	1	✓	✓

Eg: **1234GON11#Door Open#**

The 1st number & the caller number receive confirmation SMS when relay is ON(door opened).

Eg: **1234GOFF00#Door Close#**

The 1st number & the caller number will not receive confirmation SMS when relay is OFF(door closed)..

6.4.5 No need confirmation SMS when the relay is ON/OFF.

`pwdGON##`

`pwdGOFF##`

6.4.6 Control the relay ON/OFF by SMS command

`pwdCC`

Return SMS: Relay ON (or the SMS confirmation content which you modified before)

`pwdDD`

Return SMS: Relay OFF(or the SMS confirmation content which you modified before)

The relay close timer according to the before setting 6.3.3:

`pwdGOT close time #`

6.5 Digital Input.

The RTU5025 equips 2 digital inputs.

DIN1 not only special for secure door and automatically armed when door closed, SMS alert send to the 1st~6th position number immediately when door opened illegally. But also can work with motion/smoke or other sensors to protect your assets, SMS alert send to the 1st~6th position number when there have any alarm occurrence.

DIN2 for motion/smoke or other sensors to protect your assets, SMS alert send to the 1st~6th position number when there have any alarm occurrence.

On alarming situation, after alert SMS send out,RTU5025 will call the 1st ~6th number in turn until somebody pick

up the phone call. And will stop to calling after the 6th number.

6.5.1 Arm:

`pwdAA`

Disarm:

`pwdBB`

6.5.2 Define the DIN1/ DIN2 type.

`pwdDIN1NC(NO)#`

`pwdDIN2NC(NO)#`

E.g.: **1234DIN2NO#**, define the DIN2 as NO(Normally Open) type.

6.5.3 Modify the Alert SMS content when inputs alarm(Max. 32 characters).

`pwdM1(2)# sms content #`

E.g.: **1234M2#Window open alarm!#** Modify the DIN2 alert SMS content to "Window open alarm!"

DIN1 default alert SMS content: Door opened illegally.

DIN2 default alert SMS content: DIN2 Alarm.

6.5.4 Inquiry the NC/NO type and Alert SMS content of DIN1(2).

`pwdMQ#`

6.5.5 Digital alarm conditions.

The DIN1/DIN2 will trigger an alarm only under the below two conditions

- RTU5025 under the Armed Mode
- 10mins after the last call in from the authorized numbers. (10mins default, users can modify the time period by SMS command:

`pwdDxxx#`

xxx=000~999, unit: minute

xxx=000: RTU5025 will disable arm.

6.6 Others:

6.6.1 Power failure alarm (unit: minute)

`pwdACxxx#`

xxx=000~999

xxx=000: power failure alarm SMS to the 1st number once the AC/DC power supply lost.

xxx=999: default, no power failure alarm SMS to be send.

6.6.2 Self-check auto report SMS to the 1st number. (unit: hour)

pwdT#xxx#

xxx=000~999

xxx=000, default, no self-check auto report.

Auto report SMS including:

Arm/Disarm Status;
DIN1/2 status;
Relay status;
GSM signal value(full is 31,cellular signal weak if lower than 14)
AC/DC power supply status.

Inquiry the self-check and auto-report time

pwdT#

6.6.3 Inquiry current status

pwdEE

6.6.4 Inquiry the GSM modules' IMEI code and firmware version

pwdIMEI#

6.6.5 Inquiry the history record

pwdL#AABBCC#DDEEFF#

AA、DD= (year)

BB、EE= (Month)

CC、FF= (Day)

AABBCC : begin time

DDEEFF : End time

E.g.: **1234L#150109#150110#**

Means: Check history record from Jan.9th 2015 to Jan.10th 2015

Return SMS:(Example) 15-01-09 10:02:23 Armed.
15-01-09 10:05:53 DIN2 Alert
15-01-09 10:28:52 +8615012741010 Armed.
15-01-09 12:23:34 AC Power Goes OFF

.....

6.6.6 RESET the password

Switch on the device, press and hold the RESET button (closed to the SIM card holder), after 5 seconds later, the RTU5025 will restart, then release the RESET button.

This operation will reset the password to default 1234 only, other parameters reset must be reset by PC software.

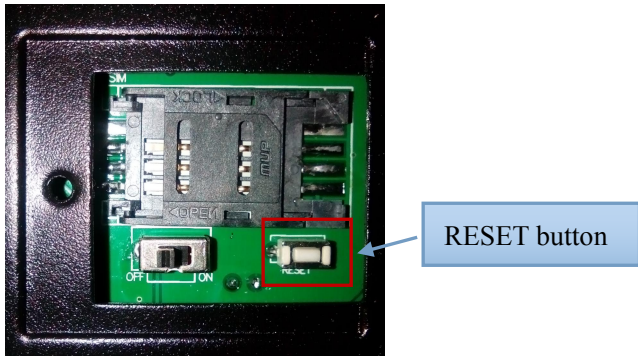

6.6.7 Device ID

RTU5025 will create an ID according to the SIM Card number (the last of 8 digits).

6.7 Data function: GPRS/UMTS/HSDPA Parameters

RTU5025 can send historical data to remote Central Management System (CMS) server software over mobile network TCP/IP, users have to build their own remote server system according to the RTU5025 data protocol.---The CMS software can be server based (\$500~\$800usd) or web based (~12,000usd), due to the high cost, this function for customer who purchased more than 100pcs RTU5025 only, for small project we suggest client using PC software to configure or read historical data via USB cable or SMS.

6.7.1 Enable data function

```
pwdGPRSON
```

Disable data function

```
pwdGPRSOFF
```

6.7.2 APN (call your mobile operator to ask the Access Point Name, private APN supported)

```
pwdG#apn name*user*password#
```

E.g.: **1234G#everywhere*eecure*secure#**

(the example "APN name: everywhere, user: eecure, password: secure" supported by Orange UK)

6.7.3 CMS Server IP address (or DNS/DDNS) and server port

```
pwdIP server IP address or DNS/DDNS name*server port#
```

E.g.: **1234IP175.164.49.20*4006#**

When data connection failure or parameters setting wrong,RTU5025 send SMS to the 1st user:

GPRS connect failure.

6.7.4 Data upload to CMS interval time:

pwdGONxxxx#

xxxx=0000~9999, (unit: minute)

xxxx=0000, data function always on,RTU5025 can receive and send data over GRPS/UMTS/HSDPA.

xxxx=9999, disable data upload function, **default**.

7. Important information

- 1) Please read the User Manual carefully before you install and control the RTU5025.
- 2) Install the RTU5025 in a hidden place.
- 3) Avoid getting water into the RTU5025.
- 4) Have a secure connection to the main power supply.

8. Maintenance

- 1) In case of failure, please contact the distributor or manufacturer.
- 2) If the RTU5025 works but fail to send SMS texts, switch the power off and on again after one minute. Test it after few minutes later, or ensure and check the settings are correct and the cellular signal strong enough.
- 3) If the RTU5025 works well with sensors but cannot send SMS texts, please change a SIM Card from another Mobile Operator's, and then testing again.
- 4) Please contact the distributor or manufacturer if the problem can't solved.

9. Warranty

- 1) The RTU5025 is warranted to be free of defects in material and workmanship for one year from the date of purchase.
- 2) This warranty does not extend to any defect, malfunction or failure caused by abuse or misuse by the Operating Instructions. In no event shall the manufacturer be liable for any alarm system altered by purchasers.

The End!

Any questions please help to contact us feel free.

www.iot-solution.com

Technical@iot-solution.com

